

GERMAN BRAND  
WINNER 2022



# GISÖHNER

## GARDEN



## CONTENTS

<b>ABOUT KÖNNER &amp; SÖHNEN®</b> .....	1
<b>K&amp;S GARDEN</b> .....	8
<b>CORDLESS GARDEN TOOLS</b> .....	10
Cordless chainsaws .....	12
Cordless hedge trimmer .....	14
Cordless leaf blower & vacuum .....	16
Cordless lawn mowers .....	18
Cordless brush cutter & String trimmer .....	20
Lithium batteries & Chargers .....	22
Robotic lawn mower .....	24
<b>ELECTRIC CHAINSAWS</b> .....	26
<b>ELECTRIC LAWN MOWERS</b> .....	28
<b>ELECTRIC BRUSH CUTTER &amp; STRING TRIMMER</b> .....	30
<b>TILLERS</b> .....	32
Electric tillers .....	34
Gasoline tillers .....	36
<b>ALL-WEATHER MULTIFUNCTION MACHINE 4 IN 1</b> .....	46
<b>LOG SPLITTERS AND WOOD CHIPPERS</b> .....	50
Electric and gasoline Log splitters .....	52
Wood chippers shredders .....	58
<b>WATER PUMPS</b> .....	62
<b>K&amp;S ACCESSORIES</b> .....	70

## DEAR KÖNNER & SÖHNEN® CUSTOMERS AND PARTNERS!

Thank you for your interest in our products. We hope that Könnner & Söhnen® equipment and accessories will become your reliable assistant!

**Könnner & Söhnen®** was created in Germany with the aim of producing high-quality, reliable equipment available for purchase by a wide range of consumers. Thanks to the many years of experience of our German specialists in the production of generators and garden equipment, we have created a series of products that meet "**TRADITIONS OF GERMAN QUALITY**" concept. This is exactly the standard of quality that is passed down from generation to generation, from the master (expert) to the students, from the father to the son, from the producer to the consumers.



Könnner & Söhnen® products have stood the test of time and meet the latest European and international standards of quality, efficiency, and environmental friendliness and cater to the needs of even the most demanding European customers.

With **more than 300 items** in 2024, Könnner & Söhnen® products are already available in **more than 20 European countries** and have been recognized by international experts and awards. We have established ourselves as a leading choice pari passu with internationally acclaimed brands and are recommended by the world-famous and regional partners.

We stay strong in pursuing our goals and keep up the tradition of German quality.

## EXCLUSIVE K&S BRANDED ENGINE

All our products are based on our in-house upgraded range of high-performance engines designed by German engineers specifically for Könnner & Söhnen®. **Könnner & Söhnen®** engines have passed multi-stage tests and investigations, with all possible defects eliminated at the production stage. We purchased a license for the manufacture of our in-house range of Könnner & Söhnen® engines under the company logo and obtained all necessary certificates of conformity to European and international quality, efficiency and environmental standards, including the latest EURO 5 emission standard.

- Guaranteed power output
- Reinforced, wear-resistant parts
- Increased lifespan
- Multi-stage tests
- Serial number
- Own brand embossing

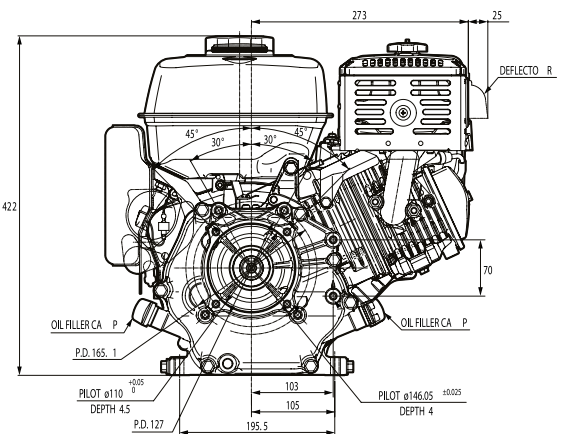

### OWN BRAND EMBOSSING

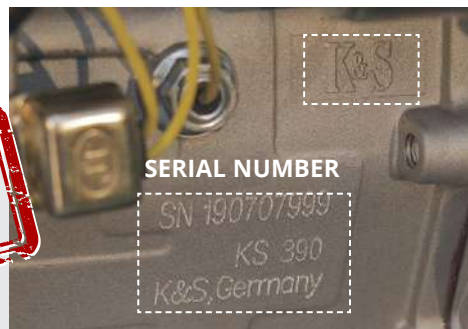

Each engine used in our generators, tillers and garden equipment has a unique serial number, allowing us to track the production and service quality.

## KÖNNER & SÖHNEN® IN 2024

In 2024, Könnér & Söhnen® products are already available and in high demand in more than **20 European countries**. Additionally, they are already present in the United States and countries in Latin America, as well as in many countries in the Middle East (Turkey, Oman, UAE, Qatar, Israel) and African countries (Morocco, Egypt, Nigeria, Ethiopia). The company has **5 offices and 3 official representations**, its own service and production centers in Europe, and a well-developed dealer network.

Currently, our equipment is showcased in more than **500 sales outlets** and is commercially available to more than **500 million people**. Every year, we open up 3-5 new markets, set up official representative offices and significantly increase our turnover.



**Head office:**  
 DIMAX International GmbH  
 Flinger Broich 203, -FortunaPark-  
 40235 Duesseldorf, Germany

● COMPANY OFFICES ● OFFICIAL REPRESENTATIONS ● AVAILABLE PRODUCTS



COUNTRIES WORLDWIDE



PRODUCT ITEMS



SALES OUTLETS



SERVICE SUPPORT



The Könnér & Söhnen® brand is dynamically developing and has interest in new business partners and sales markets.  
**Best regards, Könnér & Söhnen® team.**

## PRODUCT RANGE

Having identified all customer needs, we have carefully selected a range of products with the best features, ultimate reliability, and functionality to best meet the needs of our customers.

### K&S ENERGY

- Balcony Energy Solar Systems
- Portable power stations, solar panels
- DC Generators
- AC Generators (gasoline, LPG/Gasoline, diesel, inverter)
- Diesel power plants



### K&S GARDEN

- Battery-Powered Garden Tools (with lithium-ion battery):
  - Chainsaws
  - Lawn mowers
  - Brush cutters & string trimmers
  - Hedge trimmers
  - Leaf blowers & vacuums
- Electric garden tools:
  - Chainsaws
  - Brush cutters & string trimmers
- Log splitters
- Wood chippers
- Tillers (electric and gasoline)
- Water pumps
- Multifunctional machines 4 in 1



### K&S CONSTRUCTION

- Vibratory plate compactors
- Tamping rammers
- Compressors



### K&S AUTO

- Electric vehicle charging stations
- Jump starters
- Portable air compressors
- Car vacuum cleaners
- Automotive accessories



## STATE-OF-THE-ART TECHNOLOGY

Keeping up with the changing technologies, Könnner & Söhnen® constantly updates its product range and introduces new technologies that not only add to the reliability, ecological compatibility and operational efficiency of our equipment but also meet the needs of our customers.



As we prioritize the environment, each product line has items featuring the latest eco-friendly technology. We offer the following products that help to reduce the environmental impact:

### “ECO-FRIENDLY” ENERGY SOURCES

**Balcony Energy Solar Systems from Könnner & Söhnen®** are modern autonomous power supply systems that enable you to use your ordinary balcony as a source of clean and free solar energy.

**Könnner & Söhnen® portable chargers and solar panels** are “eco-friendly” innovative energy sources that produce no harmful waste during use and do not adversely affect the environment and the climate in general.

### COMPATIBILITY “GREEN ENERGY”

**Integration with green energy** (solar/wind power plants) - direct current generators (24-54V) and generators with a built-in ATS system can be connected to a solar charge controller for automatic battery charging and electricity supply to the house.

**EURO 5** – generators are based on K&S branded engines that meet the latest EURO 5 emission standard.

**DUAL FUEL** – models run on both LPG (propane-butane) and gasoline. LPG is more ecologically clean fuel than gasoline - ensures less emissions of harmful substances of exhaust gases into the atmosphere. LPG has a lower carbon footprint than gasoline and produces fewer exhaust emissions.

### Innovative battery system for garden and construction tools “THE SINGLE BATTERY = MANY TOOLS”

**Battery-powered garden and construction tools** are eco-friendly devices that do not generate harmful waste during operation, having no impact on the environment and climate in the region. Using a SINGLE BATTERY FOR ALL TOOLS reduces waste and eliminates the need to dispose of numerous batteries, further contributing to a positive environmental impact. Also product group of Könnner & Söhnen® garden equipment includes models featuring eco-friendly electric motors.

## QUALITY CONTROL AT EACH PRODUCTION STAGE

All Könnner & Söhnen® products are manufactured under the supervision of German engineers and tested at various stages of production. The customer service callback rate is therefore less than 1%.



### CUTTING EDGE EQUIPMENT

- Quality control of purchased spare parts for compliance with European requirements, quality and safety standards;
- Quality control at the production and assembly stage.

### IN-HOUSE SERVICE AND PRODUCTION FACILITIES IN EUROPE

- Control of each finished batch of goods before shipment;
- Quality control at our European in-house service and production center for clearance to sale.

## QUALITY CERTIFICATES

Könnner & Söhnen® products have all necessary certificates of conformity to European and international quality standards, including the latest EURO 5 emission standard.



## INTERNATIONAL AWARDS

We take pride in the high quality and reliability of **Könnert & Söhnen®** equipment recognized by international experts and prestigious awards. Fastidious and demanding German technical innovation experts have thoroughly examined and tested our products and concluded that the manufacturer Könnert & Söhnen® offers its customers reliable products that are different from the mass-produced ones. They also emphasized some exclusive product innovations and ease of use.



### FORBES DIAMONDS 2023

Poland • 2023

The Forbes magazine has awarded the **Forbes Diamonds 2023** title to DIMAX International Poland Sp. z o. o. as the fastest growing company which have chosen the right business strategy. The strategy of forming the product range with an emphasis on cutting-edge technologies and the development of new exclusive technologies, as well as the intelligent corporate structure and interaction both within the company and beyond enabled it to achieve this success.



### EXCELLENT BRANDS

Germany • 2022

In 2022 Könnert & Söhnen® was announced the winner of the **German Brand Award'22** competition in two nominations:

- Excellent Brands - Industry, Machines & Engineering
- Excellent Brands - Product Brand of the Year

Among the 1,200 submissions from exclusively German brands, the unbiased experts honored Könnert & Söhnen® products in two Excellent Brands categories: "Industry, Machines & Engineering" and "Product Brand of the Year." The evaluation criteria are transparent and openly communicated.



### PLUS X AWARD

Germany • 2019

In 2019, Könnert & Söhnen® products won the prestigious **German Plus X Award** in three nominations:

- High Quality
- Ease of Use
- Functionality

**Plus X Award** is one of the most renowned awards in the world that ascertains the quality and reliability of products. German experts confirmed that products from Könnert & Söhnen® meet the requirements for high-quality products and stated that the equipment is tailored to even the most demanding customer needs.



### GOLD MEDAL

Poland • 2018

In 2018, Könnert & Söhnen® products received the prestigious **Gold Medal Award in the Expert Choice nomination in Poland**.

Könnert & Söhnen® equipment was recognized by experienced European experts and professionals as equipment that meets the requirements of advanced technologies.

This award attests to quality of products and high production potential of Könnert & Söhnen®.



### PRODUCT OF THE YEAR

Ukraine • 2016

Könnert & Söhnen® products won the 2016 **UKRAINIAN NATIONAL OLYMPUS** award as the **BEST PRODUCT OF THE YEAR** in the **Garden Equipment & Generators** category based on value for money.

The Könnert & Söhnen® brand has occupied its niche in the medium price category, offering buyers high-quality goods with all European certificates at an affordable price.

## BUSINESS CHEETAH

Poland • 2022

Dimax International Poland Sp. z o.o. (Poland) was distinguished by the European Business Institute in the 17th edition of the **Business Cheetahs 2022 competition**, the 15th edition of the **Diamonds of the Polish Economy 2022** competition, the 15th edition of the **Efficient Company 2022** competition, and the 10th edition of the **Strong Company 2022** competition based on financial data from the National Court Register.



**Diamond of the Polish Economy statuette**



**Business Cheetah statuette**



**Efficient Company 2022 statuette**



**Strong and Trustworthy Company statuette**

The company is growing dynamically, achieving an average income and net profit growth rate of 454.8% in the years 2019-2020, earning it the title of "**Business Cheetah 2022**." Additionally, the company's effective operations were confirmed by an average net profit to income ratio of 10.7% in the years 2019 and 2020, earning it the title of "**Efficient Company 2022**." As a result, the company also earned the title of "**Strong and Trustworthy Company 2022**." The market value of the company was estimated at PLN 61 million in March 2021, earning it the title of "**Diamond of the Polish Economy 2022**." The company sells high-quality devices of the German brand Könnert & Söhnen® at affordable prices.

## BENEFITS FOR DEALERS

Thanks to a team of professionals with many years of experience in developing and selling equipment, we know exactly the needs of each sales channel and provide our partners with a complete package of necessary materials. We create all the necessary conditions for your successful sales. That is why Dimax Group provides comprehensive after-sales support to customers throughout the sales territory.

### ✓ TIME-PROVEN QUALITY PRODUCTS TESTED BY DEMANDING EUROPEAN CUSTOMERS

Our products have received numerous awards and wide recognition for both their quality and affordability.

### ✓ INTERNATIONAL CUSTOMER & PARTNER SUPPORT

- full after-sales service
- professional advice on any technical issues
- manuals, photos and videos with detailed instructions for use of the equipment
- staff product range training

### ✓ WARRANTY AND AFTER-SALES SERVICE

- customer service with original spare parts
- 2-year limited warranty

### ✓ PRE-SALES ASSESSMENT

For each finished batch of goods, a part of the goods undergoes testing at our in-house service and production center in Europe to verify compliance with the specifications approved by Könnér & Söhnen® engineers and to issue a certificate of approval for sale.

### ✓ MARKETING AND DESIGN DEPARTMENT

We provide a complete set of marketing and information materials: photos, videos, 3D reviews, promotional POS and WEB materials (catalogs, booklets, promotional mailings, banners, assistance in branding exhibition halls, website development and technical support services.)



HIGH  
QUALITY

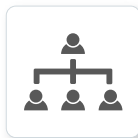

WIDE SEGMENT  
OF BUYERS



STAFF  
TRAINING



AFTER-SALES  
SUPPORT



COMFORTABLE TERMS  
OF COOPERATION



PRE-SALE  
PREPARATION

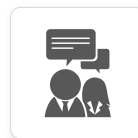

FULL MARKETING  
SUPPORT



TOP-NOTCH  
CUSTOMER SERVICE

**CHOOSING KÖNNER & SÖHNEN®, YOU BECOME PART OF A LARGE-SCALE COMPANY AND GET A TURNKEY BUSINESS**

## 100% SERVICE SUPPORT

We provide 100% customer support and after-sale service throughout the sales area.

### INTERNATIONAL CUSTOMER & PARTNER SUPPORT

- professional advice on any technical issues
- full after-sales service
- staff product range training

### VIDEO INSTRUCTIONS ON HOW TO USE OUR PRODUCTS

- commissioning
- start-up
- explanation of individual functions
- other useful tips

### WARRANTY AND AFTER-SALES SERVICE

- high-quality service with original spare parts
- international warranty



**WE ARE INTERESTED IN YOUR SUCCESS! WELCOME TO COOPERATION!**



## GROWING BRAND RECOGNITION

Our fast-growing company has potent promotion and strong sales positions in every market it enters. Every year, we participate in leading trade shows worldwide.



**GERMANY  
COLOGNE**  
2016 · 2018  
2022



**TANZANIA  
DAR ES SALAAM**  
2022



**POLAND  
POZNAN**  
2018 · 2019



**POLAND  
POZNAN**  
2016 · 2017  
2018 · 2019



**KENYA  
NAIROBI**  
2022



**UAE  
DUBAI**  
2018 · 2022



**POLAND  
WARSAW**  
2018



**ETHIOPIA  
ADDIS ABABA**  
2023



**EGYPT  
CAIRO**  
2022

## WE ARE TRUSTED BY

Customer trust is a cornerstone of the further effective development of any business. We value every customer and are proud to be recommended by globally known trading partners.



## CUSTOMER DIVERSITY

We have created a range of products with the best features for the most demanding customers. Könnér & Söhnen® products are suitable for both domestic and commercial applications.

They have the best value for money!

 <b>ADDICKS &amp; KREYE CONTAINER SERVICE GMBH</b> CONTAINER SERVICE	 <b>LUOS MASSIVHAUS GMBH</b> CONSTRUCTION COMPANY	 <b>BLUMENTRITT MEDIZINTECHNIK/ INH. THOMAS MATZIK</b> MEDICAL EQUIPMENT MANUFACTURER	 <b>THÜNEN – INSTITUT FÜR AGRARKLIMASCHUTZ</b> INSTITUTE OF AGRICULTURE FOR GLOBAL WARMING
 <b>GERICKE NUTZFAHRZEUGSERVICE UND FAHRZEUGBAU GMBH</b> TRUCK REPAIR	 <b>QUAST WASSERTECHNIK</b> SWIMMING POOL REPAIR	 <b>FISCHBACHER GMBH+CO. KG</b> CONSTRUCTION EQUIPMENT	 <b>HERIBERT &amp; HEIDI HAUSER</b> COTTAGE TOWN
 <b>CATHERINE LEBLANC</b> FITNESS CENTER	 <b>QUAD ET MOTO GENTIANE LASCOURTINES</b> SOLUTIONS FOR MOTORCYCLES AND FOUR-WHEELERS	 <b>JSC "UKRTELECOM"</b> UKRAINE'S LARGEST FIXED LINE TELECOMS PROVIDER	 <b>STATE EMERGENCY SERVICE OF UKRAINE</b> EQUIPMENT FOR FIRE MACHINES
 <b>"STEPHANE REA LA PETITE"</b> FRENCH CUISINE RESTAURANT	 <b>FURNIDE LOJA</b> GUEST HOUSE	 <b>JSC "UKRAINIAN RAILWAY"</b> UKRAINE'S LARGEST PASSENGER AND CARGO CARRIER	 <b>"112 UKRAINE"</b> INFORMATION TV CHANNEL

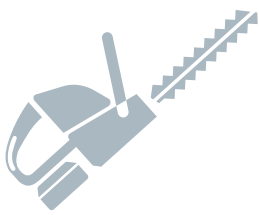
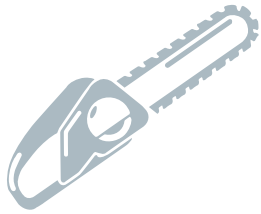



**TILLERS**



**LOG SPLITTERS**



**WOOD CHIPPERS  
SHREDDERS**

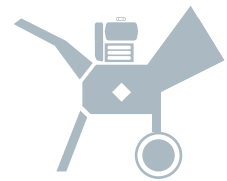

**WATER PUMPS**

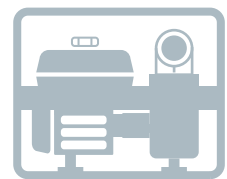

**ALL-WEATHER  
ON MACHINE 4 IN 1**

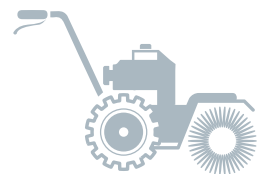

# CORDLESS GARDEN TOOLS

**Cordless garden tools from Könnert & Söhnen®** are an innovative solution in the world of cordless tools that opens up new opportunities for convenience and efficiency in work. Thanks to a diverse range of devices in the garden equipment series from Könnert & Söhnen®, any gardening tasks become achievable for both beginners and professionals.

With power starting from 20 V and capacities ranging from 2 to 8 Ah, the lithium-ion batteries from Könnert & Söhnen® serve as universal power sources for a wide array of garden tools actively used during the whole year – from brush cutters in spring and lawnmowers with trimmers in summer to garden vacuum cleaners and saws in autumn. Even chainsaws and lawnmowers receive the necessary amount of power for effective operation. The high capacity of the batteries guarantees extended runtimes, eliminating the need for frequent recharging, which becomes an integral part of significant work tasks.

Using cordless tools from Könnert & Söhnen®, gardening work becomes easier and more productive.

## CHAINSAWS



**Chain length**  
12"/14"/16"

## HEDGE TRIMMER



**Blade length**  
22"(55 cm)

## LEAF BLOWER & VACUUM



**Max air speed**  
270 km/h

## LAWN MOWERS



**Cutting height**  
25-75 mm

## BRUSH CUTTER & STRING TRIMMERS



**No-load speed**  
5500-7500 rpm

## ✓ FINANCIAL BENEFIT

A significant part of the cost of battery-powered tools is associated with the batteries. The ability to use the same battery for multiple tools ensures significant cost savings. Universal batteries from Könnert & Söhnen® are compatible with all battery-powered garden tools of our brand. Therefore, users only need to purchase a battery with the desired capacity and a charging device once, and then use them with any battery-powered tool in our series.

## ✓ CONVENIENCE DURING WORK

The usage of single battery for multiple tools significantly simplifies the work process, saves time, and reduces work interruptions. There is no need to move, store, or monitor the charge status of various batteries. If you have multiple tasks to be done, simply take one battery with yourself. Devices without batteries are much lighter in weight, enhancing overall convenience during work.

## ✓ MAXIMUM MOBILITY

Modern battery-powered gardening tools provide maximum mobility and independence from the power grid, enabling usage in hard-to-reach and remote areas. Advanced lithium-ion batteries have become more capacious and powerful, enabling the tools to work longer and with higher productivity.

## ✓ ECO-FRIENDLINESS

Battery-powered tools are eco-friendly devices that do not generate harmful waste during operation, having no impact on the environment and climate in the region. Using a single battery for all tools reduces waste and eliminates the need to dispose of numerous batteries, further contributing to a positive environmental impact.

# CORE BATTERY SYSTEM FROM KÖNNER & SÖHNEN®

- ✓ For beginners and professionals
- ✓ Quality and reliability with cost savings
- ✓ Very maneuverable and easy to drive
- ✓ Low noise level
- ✓ Without harmful emissions
- ✓ Do not require complex maintenance

UNIFIED BATTERY = MANY TOOLS



**20V + 20V**



# CORDLESS CHAINSAWS

## CORDLESS CHAINSAWS

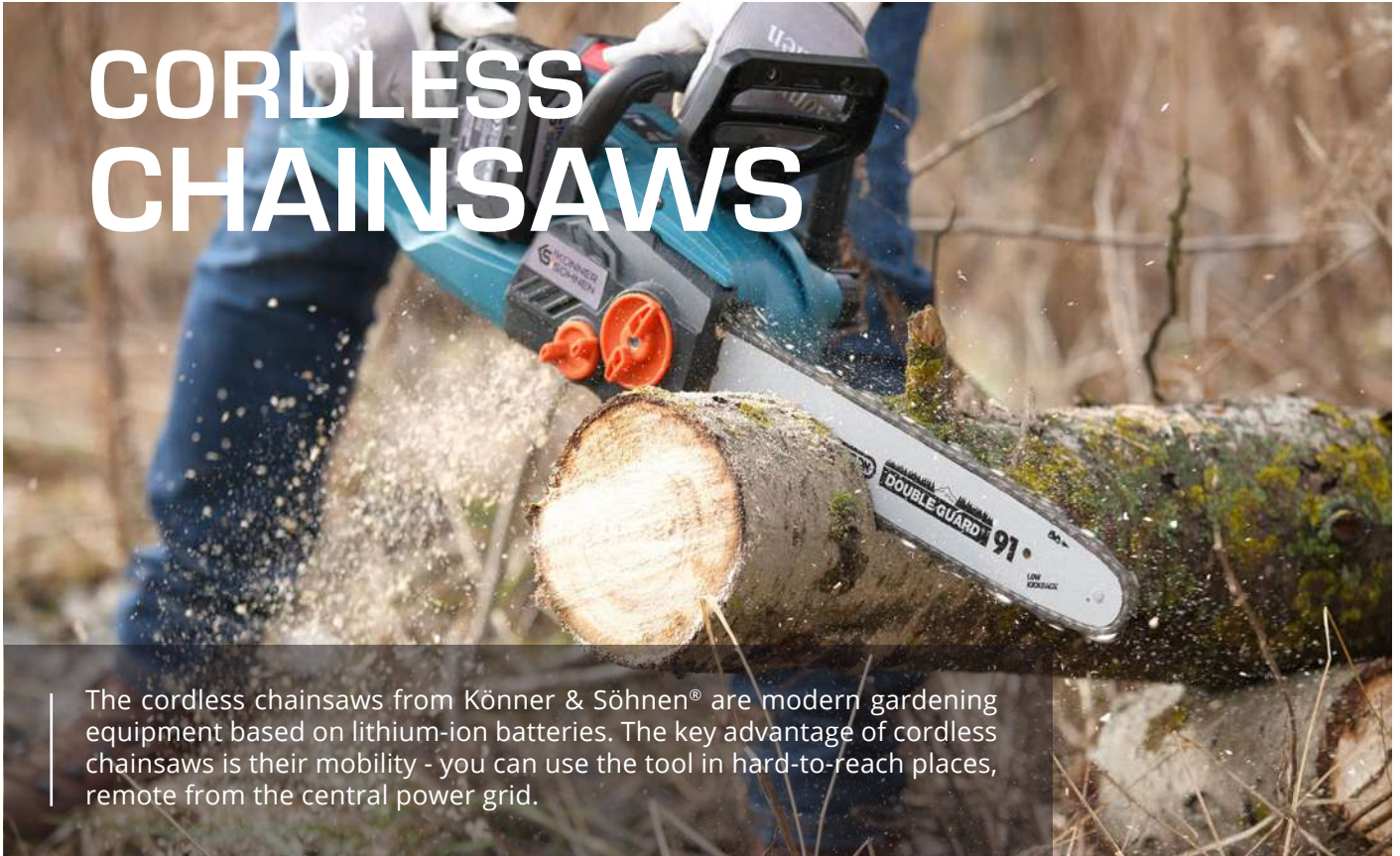

The cordless chainsaws from Könnér & Söhnen® are modern gardening equipment based on lithium-ion batteries. The key advantage of cordless chainsaws is their mobility - you can use the tool in hard-to-reach places, remote from the central power grid.

**Könnér & Söhnen® cordless chainsaws** are distinguished by their compact dimensions and light weight, ensuring maximum user comfort. The KS CS20V-12, with an engine speed of 3000 rpm, is a handy, compact model and the ideal solution for trimming branches in the garden.

The more powerful KS CS40V-14 and KS CS40V-16 models, based on a brushless engine with a speed of 8000 rpm, provide high productivity and are the optimal solution for harvesting of firewood. This type of engine minimizes maintenance and extends the service life of the device.

### Battery voltage



20 V/40 V

### Chain length

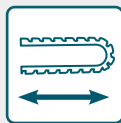

12"/14"/16"

### Chain speed



5,6 – 15 m/s

### Working speed



3000 – 8000 rpm

### ✓ AUTOMATIC CHAIN LUBRICATION

Könnér & Söhnen® chain saws are equipped with a modern automatic chain lubrication system. During operation, an integrated pump supplies the required amount of lubricating material to the bar and chain, ensuring reliable and uninterrupted lubrication for optimal productivity and an extended saw service life.

### ✓ "TOOL-FREE" CHAIN TENSIONING MECHANISM

The tool-free chain tensioning system, designed without the need for tools, is a highly convenient and crucial feature that enables quick and easy adjustment of the chain tension on the bar. There is no need for using extra tools! Proper chain tensioning improves cutting efficiency, helps prevent extra wear, and ensures reliable and safe tool operation.



Könner & Söhnen® cordless chainsaws operate on modern, **high-quality 20 V\* lithium-ion batteries** with capacities ranging from 2 to 8 Ah, providing an extended service life. The compact size and lightweight design of the batteries make them ideal for working with equipment without a feeling of extra heaviness. These batteries can boast about their high efficiency, rapid charging capability, and minimal power loss during standby mode.

\*Battery and charger are not included in the package.



CORDLESS CHAINSAWS



Original Oregon tire and chain

- ✔ "Tool-less" chain adjustment for convenient operation and maintenance
- ✔ Ergonomic rubber anti-slip handle effectively reduces vibration and slip
- ✔ Automatic oiling system extends the life of your chain
- ✔ Lightweight design ensures easy maneuverability in different cutting orientations



KS CS20V-12



KS CS40V-14



KS CS40V-16

	KS CS20V-12	KS CS40V-14	KS CS40V-16
Rated voltage	20 V	40 V (20 V+20 V)	40 V (20 V+20 V)
Battery capacity (not included in the set)	2-8 Ah	2-8 Ah	2-8 Ah
Working speed	3000 rpm	8000 rpm	8000 rpm
Chain length	12" (30 cm)	14" (35 cm)	16" (40 cm)
Motor type	brush motor	brushless motor	brushless motor
Chain speed	5,6 m/s	15 m/s	15 m/s
Oil tank capacity	300 ml	250 ml	250 ml
Chain tensioning without a tool	+	+	+
Gross dimensions (L×W×H)	455×225×230 mm	455×220×255 mm	455×220×255 mm
Net weight	3,5 kg	3,6 kg	3,6 kg
Gross weight	4.2 kg	4,6 kg	4,6 kg



## CORDLESS HEDGE TRIMMER

# CORDLESS HEDGE TRIMMER

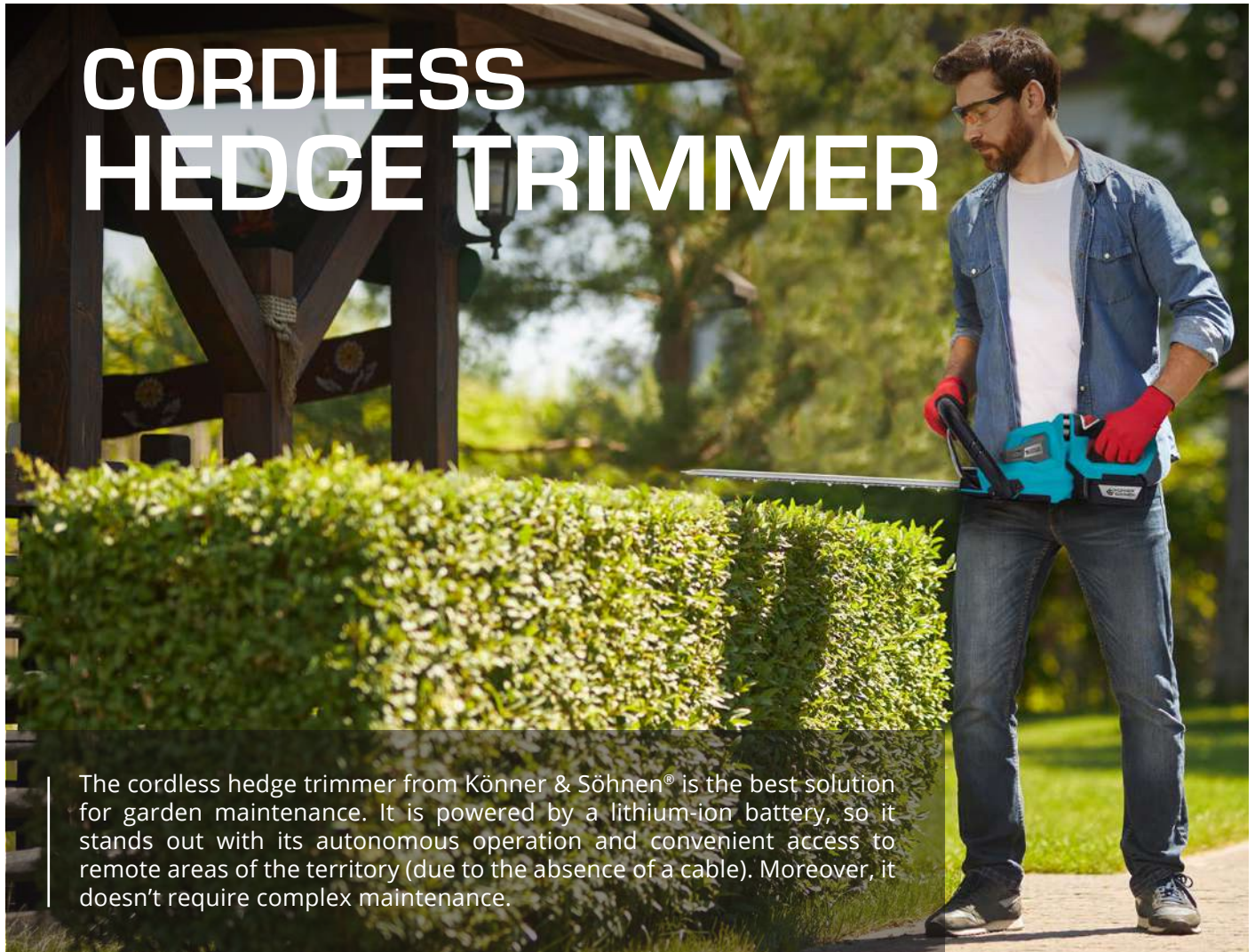

The cordless hedge trimmer from Könnert & Söhne® is the best solution for garden maintenance. It is powered by a lithium-ion battery, so it stands out with its autonomous operation and convenient access to remote areas of the territory (due to the absence of a cable). Moreover, it doesn't require complex maintenance.

The highly mobile and grid-independent **hedge trimmer** from Könnert & Söhne® has a high power and is distinguished by low vibration. Thanks to its low weight of 3,5 kg and compact dimensions, as well as a 180° rotating handle for maximum comfort, it enables easy adjustment of the cutting angle. This makes it an indispensable assistant in garden care for trimming bushes and branches up to 16 mm in diameter, as well as for cutting hedges and shaping plants.

Rated voltage



20 V

Battery capacity\*



2 – 8 Ah

Cutting length

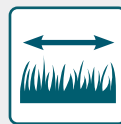

22" (55 cm)

Max cutting diameter



Ø 16 mm

The cordless brushcutter KS HT-20V has a high level of safety, equipped with a two-handle control system with protection against accidental start on the handle, which eliminates the possibility of unplanned tool startup. In addition, it is equipped with a protective guard in front of the handle, which does not restrict the view of the working area during use, while effectively protecting the hand from flying debris.

**THE KS HT-20V CORDLESS BRUSHCUTTER IS THE PERFECT CHOICE FOR ANYONE LOOKING FOR A RELIABLE TOOL FOR GARDENING!**





### SOFT START

The soft start function helps prevent a sudden start and avoids too heavy loads on the engine. This provides a comfortable start without jerking, eliminating the risk of unexpected actions.

### ✓ BLADE WITH LASER SHARPENING OF 55 CM

The 55 cm long cutting blade with double-action blades is made of durable steel with laser sharpening for a perfectly sharp cutting edge. It's effective for cutting both fresh shoots and branches of various plant species.

### ✓ THOUGHTFUL DESIGN

The rubberized handle is adapted for the tightest possible grip of the tool, preventing the user's hand from slipping. It has 5 rotation positions at 180° for efficient and comfortable work at any angle.

### ✓ LI-ION BATTERY WITH A VOLTAGE OF 20 V (not included in the set)

The brushcutter is powered by a 20V Li-Ion battery from 2,0 to 8,0 Ah. This is a tool from the Könnér & Söhnen® gardening equipment line based on a single battery system. It features fast charging speeds and reduced downtime.

#### Rotating handle

Handles are adjustable horizontally on 180° (It has 5 rotation positions)



**CUTTING LENGTH 22"**  
55 cm

Safety switch

Protective baffle

Max cutting diameter 16 mm (3/5")

Dual-action blades  
(2×branches at one time)

**BATTERY IS NOT INCLUDED** 20V

\*Battery and charger are not included in the package.

The external gearbox provides convenient access to parts, making its maintenance easier and faster

CORDLESS HEDGE TRIMMER

## KS HT-20V

Rated voltage	DC 20 V
Battery capacity (not included in the set)	2 - 8 Ah
No-load speed	1550 rpm
Cutting length	22" (55 cm)
Max cutting diameter	16 mm
Gross dimensions (L×W×H)	930×220×200 mm
Net weight	2,5 kg
Gross weight	3,5 kg

- ✓ Best choice for overgrown hedges and bushes
- ✓ High power and low vibration
- ✓ Lightweight ergonomic design



# CORDLESS LEAF BLOWER & VACUUM



The cordless leaf blower is another part of Könnner & Söhnen® unified cordless system of garden tools. This multifunctional tool is ideal for cleaning the outdoor area and garden.

The garden **cordless vacuum-blower** with leaf shredding (mulching) function from Könnner & Söhnen® is a convenient multifunctional tool that significantly saves time and effort during territory cleaning. It is lightweight, compact, independent of the power grid. It has 4 operating speeds plus Turbo mode, enabling you to choose the necessary mode for various needs.

In addition, it is extremely easy to use, easy to assemble and requires almost no technical maintenance.

**Rated voltage**



**40 V MAX**

**Max wind capacity**



**550 m<sup>3</sup>/h**

**Dust bag volume**



**45 L**

**Air speed**



**270 km/h**

## **EASY TO USE**

This garden device from Könnner & Söhnen® features the ability for tool-free, quick nozzle changes, with just one button. Thanks to this feature, the vacuum cleaner can be easily transformed into a powerful blower without extra effort. It also stands out for its compact size and lightweight design, weighing only 3,5 kg for maximum user comfort. The shoulder strap with a soft padding enables you to balance the working weight, hold the device safely and relieve the operator's hands.

## **MOBILITY**

One of the key advantages of this multifunctional vacuum cleaner is its mobility and independence from the power grid. It is powered by modern, high-quality 20 V\* lithium-ion batteries with capacity ranging from 2 to 8 Ah, which are characterized by a long service life, their compact size and light weight, which do not weigh down the machine. They not only guarantee high performance, but also make it possible to use the tool in hard-to-reach places, away from the central power grid. In addition, these batteries can be used with other tools from the Könnner & Söhnen® gardening range.



## LEAF BLOWER | VACUUM CLEANER | SHREDDER

This 3-in-1 garden tool from Könnér & Söhnen® efficiently handles essential functions in cleaning the area: in suction mode, it helps collect garden waste, leaves, branches, or other small debris, dust, and sawdust. The voluminous 45-liter trash bag enables you to collect a large amount of waste. Thanks to the integrated shredder, it can mulch leaves and grass, reducing their volume to 1:10 times the original size. The obtained mulch can be used as fertilizer on the field. In blower mode, it provides an airspeed of 270 km/h - so it easily blows away dirt, leaves or debris from the paths, and cleans surfaces.



**BRUSHLESS MOTOR**

The use of a brushless engine ensures high efficiency and long service life, while with fewer moving parts, that require maintenance and reducing the noise level during operation.

Battery status Indicator (low, medium, full)

4 Speed + Turbo mode

Soft-grip handle



### Intelligent control

The electronic module controls the engine speed in various modes of operation. The control panel enables users to adjust the speed with a single button, depending on the user needs.

Vacuum tube

45 l dust bag



\*Battery and charger are not included in the package.

- ✔ Mulching function
- ✔ Tool-less and only one button to quick assemble the air tube
- ✔ Intelligent control
- ✔ Single quick release belt for carrying

### KS LBV-40V

Rated voltage	40 V (20 V+20 V)
Battery capacity (not included in the set)	2 - 8 Ah
Max No-load speed	16300 rpm
Max Air speed	270 km/h
Max productivity	550 m <sup>3</sup> /hh)
Dust bag volume	45 l
Speed	4 Speed+Turbo mode
Gross dimensions (L×W×H)	470×280×360 mm
Net weight	3,5 (V)/2,7 (B) kg
Gross weight	4,6 kg

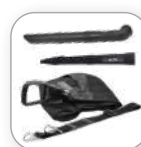

#### ACCESSORIES IN A SET:

- Vacuum tube
- Blow tube with in scraper
- Shoulder strap
- 45 l dust bag



Könner & Söhnen® cordless lawnmowers, based on a single battery system for the range of garden tools from our brand, are the ideal solution for lawn care. The main advantage of these cordless lawnmowers is the absence of cables and extensions from the primary power grid, guaranteeing maximum mobility and operational autonomy.

Könner & Söhnen® **cordless lawnmowers** offer a number of significant advantages compared to similar models from other manufacturers. They are based on powerful brushless engines with a speed of up to 3300 rpm, which can easily cope with even heavy loads. The using of brushless engines ensures high efficiency, an extended service life, and reduced noise. Additionally, this type of engine has fewer moving parts that require maintenance.

**Rated voltage**



**20 V/40 V**

**Cutting width**



**330–430 mm**

**Cutting height**

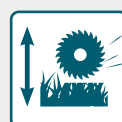

**25–75 mm**

**No-load speed**



**3200–3300 rpm**

 **2-IN-1 FUNCTION: GRASS COLLECTION OR MULCHING**

Könner & Söhnen® mowers have the option for both collecting mowed grass and mulching it right after cutting. The mulching function is particularly useful for fertilizing the lawn and improving its condition. With a cutting width of up to 43 cm, Könner & Söhnen® mowers can mow and mulch efficiently even on large lawns.

 **CUTTING HEIGHT ADJUSTMENT 25-75 MM**

The convenient mowing level adjustment lever has 5 or 6 positions (depending on the model), the cutting height range is from 25 mm to 75 mm, which makes it possible to customize the mower to the individual needs of the user and enabling you to achieve the optimal lawn height.

 **COMBINED GRASS CATCHER**

The mower grass catchers are made of a combination of plastic cover and a frame bag made of shield fabric, which does not weigh down the mower, retains its shape, and has good rotation. The 30- or 50-liter capacity of the containers allows you to collect a sufficient volume of grass clippings. They are equipped with a container fullness indicator.

 **SAFETY KEY**

The lawnmower is equipped with a complex safety system, including an activation key that must be inserted to turn on the tool. If the key is removed, the lawnmower automatically switches off, preventing unintended activation and ensuring safety during storage and transportation.



**BRUSHLESS  
MOTOR**

### RELIABLE BRUSHLESS ENGINE

The eco-friendly engine with brushless technology guarantees a longer service life and significantly increases productivity with minimal energy consumption. It is distinguished by its high power, low vibration and reduced noise level. It does not produce harmful emissions during operation.



### Intelligent speed control

Equipped with automatic engine speed control during operation to ensure optimal energy consumption and maximum mowing productivity



Height adjustable handles for convenient usage and compact storage

Battery status Indicator (low, medium, full)

Foldable handle with quick release clamp

Carry handle

Cutting height adjustment lever, 5 or 6 cutting height positions (25-75 mm)

Wheels

Full bag indicator

Mulching function

Grass collecting bag



\*Battery and charger are not included in the package.

- ✓ Excellent maneuverability due to balanced weight
- ✓ Low vibration level
- ✓ Tool-free assembling
- ✓ Compact storage



**KS 33LM-20V**



**KS 43LM-40V**

Rated voltage	20 V	40 V (20 V+20 V)
Battery capacity (not included in the set)	2-4 Ah	2-4 Ah
No-load speed	3200 rpm	3300 rpm
Motor type	brushless motor	brushless motor
Cutting width	330 mm	430 mm
Adjustable height position	25-75 (5 positions)	25-75 (6 positions)
Collection bag	30 l	50 l
Mulching function	+	+
Wheels front/rear	5,5"/6,5"	7"/10"
Gross dimensions (L×W×H)	690×410×330 mm	804×484×400 mm
Net weight	9,5 kg	12,5 kg
Gross weight	11,2 kg	15 kg



## CORDLESS BRUSH CUTTER & STRING TRIMMER



The Könnert & Söhnen® cordless series includes models of cordless brush cutters – easy-to-use devices that help you keep your lawn in perfect condition in areas that cannot be treated with lawn mowers. They are quiet and require no complex technical maintenance.

The Könnert & Söhnen® **cordless trimmers** are equipped with lithium-ion batteries of 20V/40V ranging from 2 to 8 Ah, distinguished by their rapid charging abilities, minimizing idle time.

**Rated voltage**



**20 V/40 V**

**Battery capacity\***



**2 – 8 Ah**

**Cutting width**

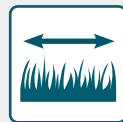

**12" (30 cm)**

**No-load speed**



**5500–7500 rpm**

### ✓ FLEXIBLE USE

Könnert & Söhnen® brush cutters are designed to meet different user needs, due to their flexibility. They feature two nozzles: a three-blade knife and a spool with a line – designed for specific operating modes. The knife is tailored for more difficult tasks in the open field where there are no obstacles. It will quickly cope with neglected shrubs and sturdy plants. A trimmer nozzle with a line is suitable for precise trimming around obstacles, plants, trees, borders, etc. It has an automatic line feed. The KS BCT-40V model enables users to select rotation speed and an energy-saving mode, making the battery energy consumption more efficient.

### ✓ EASY TO OPERATE AND MAINTAIN

The trimmer handle can be adjusted to various heights, enabling the trimmer to be adapted to any user height. The shoulder strap with a soft padding helps balance the working weight, hold the device without harm to health, and relieves the operator's hands. In addition, they can be easily assembled and disassembled within several minutes for easy transport and compact storage. They do not require complex technical maintenance (due to the absence of fuel mixtures, filters, etc).

### ✓ OVERHEAT PROTECTION

The overheat protection function is an important safety feature of our trimmers, preventing potential battery harm. In case of reaching a critical temperature, the trimmer automatically switches off to cool down - extending the battery life.



**BRUSHLESS  
MOTOR**

### POWERFUL BRUSHLESS ENGINE

Powerful brushless engines provide high torque with a maximum speed of 7,500 rpm, ensuring excellent cutting speeds under load, as well as extended operating time on a single battery charge. The KS BCT-40V is equipped with a speed controller depending on the selected operating mode to use the battery charge more efficiently. Brushless engines are characterized by a long service life and a reduced noise level, with no need for complex technical maintenance.



**RPM**  
ECO AUTO TURBO

The ability to select the level of speed level for each operating mode (for KS BCT-40V model)

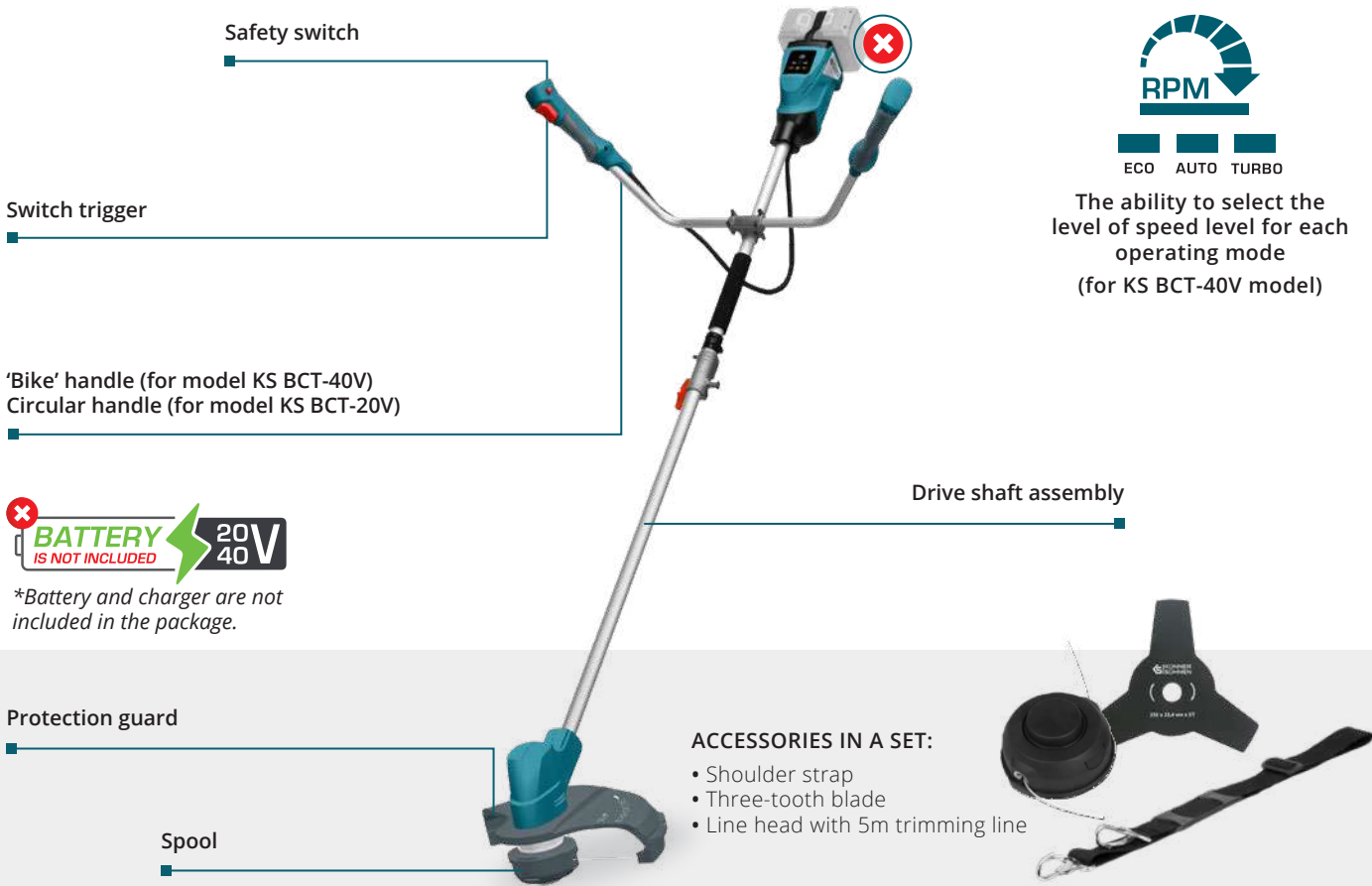

- ✓ Three tooth blade & trimming line for diverse tasks
- ✓ Powerful brushless motor with 7500 rpm speed
- ✓ The split shaft allows convenient transport and storage



	KS BCT-20V	KS BCT-40V
Rated voltage	DC 20 V	DC 40 V (20 V+20 V)
Battery capacity (not included in the set)	2 - 8 Ah	2 - 8 Ah
Motor type	brushless motor	brushless motor
Max Cutting width (spool)	12" (300 mm)	12" (300 mm)
Cutting width (cutting disc)	255 mm	255 mm
Knife	3 teeth	3 teeth
Line diameter	Ø2 mm	Ø2 mm
No load speed	5500-7500 rpm	5500-7500 rpm
Gross dimensions (L×W×H)	970×270×100 mm	970×270×100 mm
Net weight	3,8 kg	3,6 kg
Gross weight	4,8 kg	4,9 kg

# Choose versatile

# 20V LITHIUM BATTERY

which will be suitable for all of your power tools

Modern **lithium-ion batteries** from Könnor & Söhnen® are highly reliable and durable. Their service life is three times longer than lead-acid batteries. They are lightweight and compact, but at the same time, have high battery capacity, and do not require maintenance during the entire lifespan.



Additionally, they are equipped with the highest level of protection and feature charge level indication.

Könnor & Söhnen® battery chargers provide a stable power during operation and provide protection against battery damage. These chargers come with LED indicators that display the battery charge status.

## MULTI-LEVEL PROTECTION AGAINST



Overcharge protection



Over-discharge protection



Short circuit protection



Over Current protection



Over/Under Voltage Protection



Overtemperature protection





<b>KS 20V2-1</b>	
Rated voltage	20 V
Battery capacity	2 Ah
Battery type	Lithium-ion battery
Gross dimensions (L×W×H)	125×85×60 mm
Net weight	0,47 kg



2 Ah

<b>KS 20V4-1</b>	
Rated voltage	20 V
Battery capacity	4 Ah
Battery type	Lithium-ion battery
Gross dimensions (L×W×H)	125×85×75 mm
Net weight	0,79 kg



4 Ah

<b>KS 20V4-2</b>	
Rated voltage	20 V
Battery capacity	4 Ah
Battery type	Lithium-ion battery
Gross dimensions (L×W×H)	130×90×80 mm
Net weight	0,68 kg



4 Ah

<b>KS 20V6-2</b>	
Rated voltage	20 V
Battery capacity	6 Ah
Battery type	Lithium-ion battery
Gross dimensions (L×W×H)	130×90×80 mm
Net weight	1,09 kg



6 Ah

<b>KS 20V8-2</b>	
Rated voltage	20 V
Battery capacity	8 Ah
Battery type	Lithium-ion battery
Gross dimensions (L×W×H)	130×90×80 mm
Net weight	1,1 kg



8 Ah



**CHARGERS FOR  
20V LITHIUM BATTERY**

Charger for 20 V  
Lithium battery



Fast charger for 20 V  
Lithium battery



Dual-port fast charger for 20 V  
Lithium battery

	<b>KS C24A</b>	<b>KS C45A</b>	<b>KS C35A-2</b>
Rated voltage	230 V/50 Hz	230 V/50 Hz	230 V/50 Hz
Nominal output voltage	21,5 V	21,5 V	21,5 V
Nominal output current	2,4 A	4,5 A	2×3,5
Safety class	II	II	II
Gross dimensions (L×W×H)	170×85×115 mm	185×80×120 mm	220×73×167 mm
Net weight	0,42 kg	0,55 kg	0,89 kg
Gross weight	0,44 kg	0,58 kg	0,95 kg

# ROBOTIC LAWN MOWER

The robotic lawnmower from Könnert & Söhnen® is a dream of every gardener. It absolutely independently takes care of the lawn and keeps it in perfect condition without user participation. The mower is fully automated thanks to its numerous integrated sensors, which detect the mowing boundaries and avoid obstacles during operation.

The **robotic lawnmower** from Könnert & Söhnen® is a highly productive cordless tool designed for areas up to 900 m<sup>2</sup>, including steep slopes with an incline of up to 25 degrees/47%. It features 8 cutting height levels ranging from 25 to 65 mm. The cutting width reaches 220 mm. The mower mulching function provides efficient shredding of grass right after mowing, eliminating the need to collect and dispose of the cut grass. The even spreading of shredded grass on the lawn becomes an additional source of nutrition, improving its condition.

**Rated voltage**



**20 V**

**Cutting width**



**220 mm**

**Cutting height**



**25–65 mm**

**No-load speed**



**3100 rpm**

## **MAXIMUM AUTOMATION**

The smart robotic lawnmower is equipped with all the necessary sensors for maximum automation, as well as the **function of automatically returning** to the charging station when work is complete. The mower schedule can be programmed to set the times and days when mowing is required. **Lift and tilt sensors** provide reliable protection by stopping the blades as soon as the robotic lawnmower is lifted or tilted too much. If objects are detected in the device's path, it activates an **obstacle sensor**, enabling the mower to change direction and avoid them. In case of an accidental collision, the mower activates its **impact sensor**, which causes an immediate stop of the blades and prevents possible damage of the mower. The **rain sensor** detects precipitation and automatically returns the mower to the charging station. The Könnert & Söhnen® lawnmower has a **water splash protection class of IPX4**.

## **LITHIUM-ION BATTERY**

The robotic lawnmower is equipped with a reliable lithium-ion battery that has an output power of 20 W and a capacity of 4.0 Ah. This battery provides long, uninterrupted operation of the device, ensuring a stable power supply for maximum productivity. The average battery life on a full charge is 70 minutes, enabling the lawnmower to efficiently cover a large area. Thanks to its fast-charging lithium-ion battery, the mower has reduced idle time. The advantage of modern lithium batteries is their high energy density. Compared to older types of batteries, they stand out for their high capacity at a lower weight and size. Thus, a small and lightweight lithium battery can power an engine for as long as a lead battery, which is several times larger and heavier.



### REMOTE CONTROL

Könnér & Söhnen® robotic lawnmowers are innovative devices that can be controlled remotely through a mobile app or Bluetooth/Wi-Fi connection. You can set up the schedule of the device, initiate remote start, and monitor the working process – all of this can be easily done from your mobile phone or tablet.

- ✓ Protection against unauthorized use and theft - no one can start the lawnmower without a PIN code.
- ✓ User protection - automatic instant stop of the blades when lifting the mower



### BRUSHLESS MOTOR

The usage of a brushless engine ensures a high efficiency and a long service life of the device. This type of engine has fewer moving parts that require maintenance and is characterized by a reduced noise level during operation.

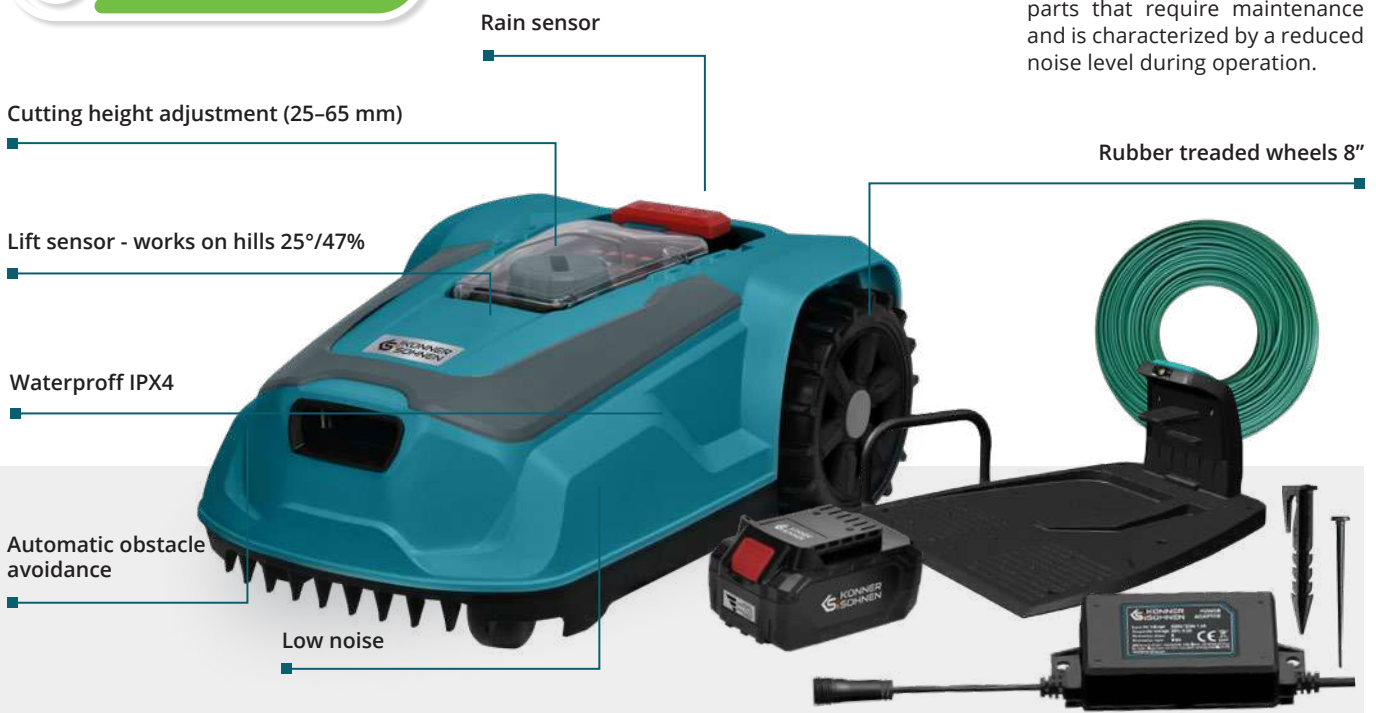

ROBOTIC LAWN MOWER

KS 22RLM	
Motor voltage	<b>20 V</b>
Suitable for area	<b>up to 900 m<sup>2</sup></b>
Mowing time per battery charge (4 Ah)	<b>approx. 70 min*</b>
Drive speed	<b>1,2 km/h</b>
No-load speed rotation	<b>3100 rpm</b>
Cutting height (8 positions)	<b>25-65 mm</b>
Cutting width	<b>220 mm</b>
Max slope	<b>25°/47%</b>
Wheels	<b>8"</b>
APP/Wi-Fi/Bluetooth	<b>+</b>
Gross dimensions (L×W×H)	<b>470x280×360 mm</b>
Net weight	<b>9 kg</b>
Gross weight	<b>18 kg</b>

#### SELF-INSTALLATION KIT IS INCLUDED:

- Boundary wire – 170 m
- Hooks – 230 pcs
- Nails for fixing charging station – 6 pcs
- Charging station
- Adaptor
- Lithium-ion battery 20V



\*Depending on the type of grass, growing conditions, humidity and flatness of the lawn area.



## ELECTRIC CHAINSAWS

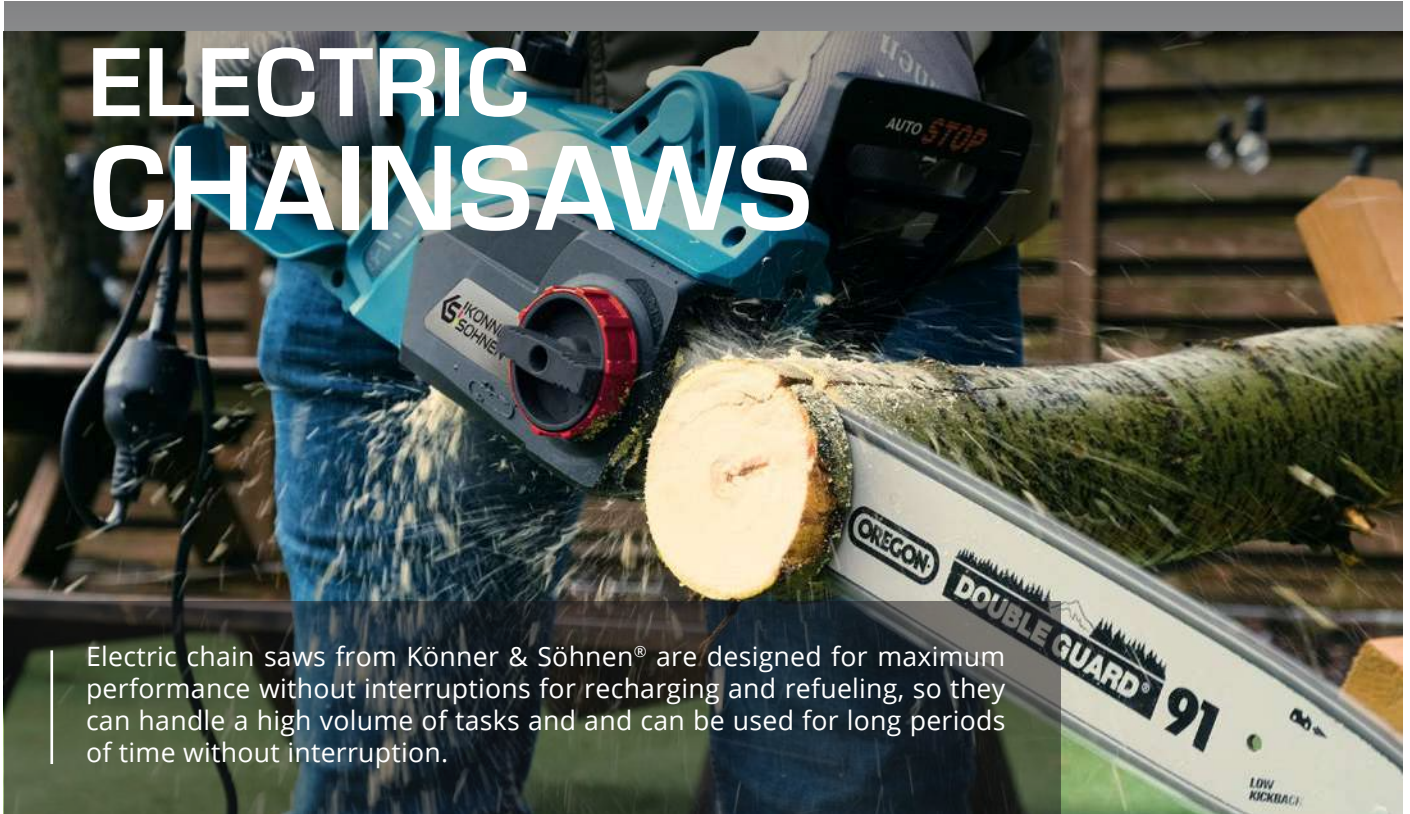

Electric chain saws from Könnér & Söhnen® are designed for maximum performance without interruptions for recharging and refueling, so they can handle a high volume of tasks and can be used for long periods of time without interruption.

**Electric chain saws** from Könnér & Söhnen® are characterized by their light weight, high maneuverability, reversibility and long service life. They are distinguished by their lightweight and compact size, making them ideal for use in restricted areas. They do not produce harmful emissions during operation, so they can be used in enclosed spaces.

### Rated power



1800 – 2400 W

### Operating voltage



230 V/50 Hz

### Chain length

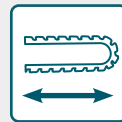

14"/16"/18"

### Chain speed



13 – 15 m/s

### ✓ AUTOMATIC CHAIN LUBRICATION

Könnér & Söhnen® chain saws are equipped with a modern automatic chain lubrication system. During operation, an integrated pump supplies the required amount of lubricating material to the bar and chain, ensuring reliable and uninterrupted lubrication for optimal productivity and an extended saw service life.

### ✓ "TOOL-FREE" CHAIN TENSIONING MECHANISM

The tool-free chain tensioning system, designed without the need for tools, is a highly convenient and crucial feature that enables quick and easy adjustment of the chain tension on the bar. There is no need for using extra tools! Proper chain tensioning improves cutting efficiency, helps prevent extra wear, and ensures reliable and safe tool operation.

### ✓ SOFT START SYSTEM

The soft-start function of Könnér & Söhnen® electric chainsaws ensures that the chain speed rises smoothly without jerking, preventing the too heavy loads on the engine. This ensures a comfortable start to work and eliminates the risk of unexpected actions.

### ✓ MAXIMUM LEVEL OF PROTECTION

Electric chain saws from Könnér & Söhnen® are equipped with integrated safety functions. The regulated guard in front of the handle works as double emergency protection - in case of unexpected circumstances, it switches off the power supply and stops the chain. The power button lock prevents the tool from being switched on accidentally.



## HIGH POWER ENGINES UP TO 2400 W

The electric engines used in Könnér & Söhnen saws are distinguished by high reliability and a long service life. They do not produce harmful emissions into the atmosphere during operation. The engines have a maximum power of 2400W and a speed of 13 to 15 m/s, that guarantee efficient sawing of firewood and high productivity.

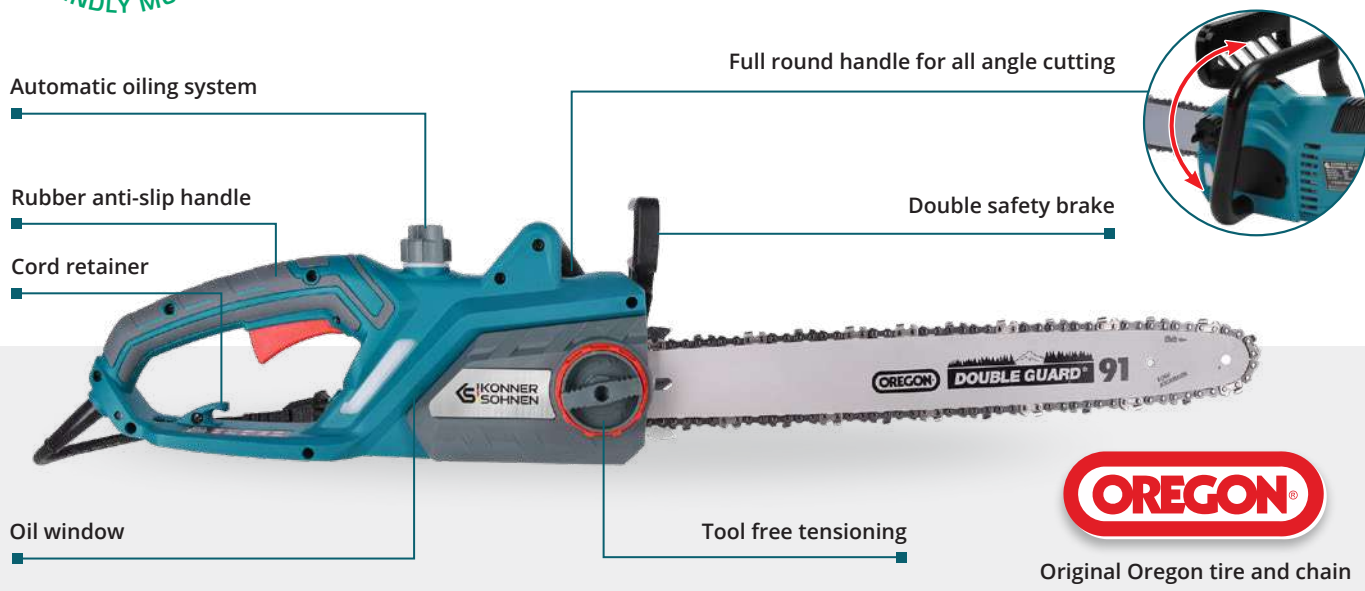

ELECTRIC CHAINSAWS

- ✔ "Tool-less" chain adjustment for convenient operation and maintenance
- ✔ High chain speed (up to 15 m/s) for improved cutting performance
- ✔ Automatic oiling system extends the life of your chain
- ✔ Ergonomic rubber anti-slip handle effectively reduces vibration and slip
- ✔ Lightweight design ensures easy maneuverability in different cutting orientations



	KS CS1800-14	KS CS2200-16	KS CS2400-18
Rated power	1800 W	2200 W	2400 W
Operating voltage	230 V	230 V	230 V
Frequency	50 Hz	50 Hz	50 Hz
Chain length	14" (35 cm)	16" (40 cm)	18" (45 cm)
Chain pitch	3/8"	3/8"	3/8"
Chain gauge	050" (1,3 mm)	050" (1,3 mm)	050" (1,3 mm)
Chain speed	15 m/s	14 m/s	13 m/s
Oil tank capacity	280 ml	140 ml	190 ml
Double safety brake	+	+	+
Chain tensioning without a tool	+	+	+
Soft start	-	+	+
Overload protection	-	+	+
Gross dimensions (L×W×H)	500×285 ×200 mm	545×225×255 mm	510×265×200 mm
Net weight	4,7 kg	5,2 kg	5,7 kg
Gross weight	5,4 kg	5,9 kg	6,3 kg



Könner & Söhnen® electric lawn mowers offer maximum performance without interruptions for recharging and refueling. Powerful electric engines up to 1800 W with a speed of 3000 to 3450 rpm guarantee high performance, efficiently cutting various types of plants - from lawns to wild weeds.

The Könner & Söhnen® **electric lawn mower** range includes a variety of models to meet every consumer's need - from the most compact and lightweight models, easily handled by users of all ages and genders, to high-powered units designed for more complex tasks.

These lawn mowers are distinguished by their high strength and durability. The thoughtful design features a balanced center of gravity, ensuring efficient maneuverability on different terrains.

**Rated power**



**1000–1800 W**

**Voltage**



**230 V/50 Hz**

**Cutting width**



**320–420 mm**

**Cutting height**

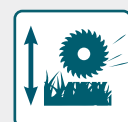

**25–80 mm**

 **CUTTING HEIGHT ADJUSTMENT 25-80 MM**

The convenient cutting height adjustment lever has 3 or 5 positions (depending on the model) with a cutting height range from 25 mm to 80 mm. This provides the opportunity to customize the lawn mower according to the user's individual needs and achieve the optimal lawn height.

 **EASY TO OPERATE AND STORE**

The lawn mowers are ergonomically designed with superior quality in every component: an adjustable handle height for user customization (in the models KS 38LM, KS 42LM), one-handed operation, and a cable holder for easy cable fixation. The folding handle provides a compact storage. In the powerful KS 38LM and KS 42LM models, the handlebars have a special silicone foam coating that effectively dampens vibrations, providing a confident and firm grip.

 **TOOL-FREE ASSEMBLY**

Könner & Söhnen® electric lawn mowers have a simple design, making preparation for work, maintenance, or storage quick, easy, and tool-free.

 **COMBINED GRASS CONTAINER**

The grass catchers of the mowers are made of a combination of materials (except for the KS 32LM) - featuring a plastic cover and a frame bag made of durable fabric. This modification keeps the lawnmower lightweight and ensures that the containers maintain their shape, provide good ventilation, and can be easily shaken out if necessary. The container capacity of these models is 40 or 50 liters, enabling you to collect a sufficient volume of grass clippings. They are also equipped with a container fill indicator. The KS 32LM mower container is made of lightweight and durable plastic, resistant to deformation. It does not crack or fade in the sun and is easy to empty and wash with water.

### BRUSHLESS ENGINE

The KS 38LM-BL lawn mower is based on a brushless engine, ensuring enhanced efficiency, an extended lifespan and reduced noise levels. Additionally, the engine has fewer moving parts that require maintenance.

### MULCHING FUNCTION

The KS 42LM is equipped with a mulching function, particularly useful for fertilizing and improving the condition of your lawn. The mower has a cutting width of 42 cm, ensuring effective mowing and mulching, even on larger lawn areas.



ELECTRIC LAWN MOWERS

- ✔ Excellent maneuverability due to balanced weigh
- ✔ Low vibration level
- ✔ Tool-free assembling
- ✔ Compact storage



KS 32LM



KS 38LM-BL



KS 38LM



KS 42LM

Rated voltage	230 V	230 V	230 V	230 V
Frequency	50 Hz	50 Hz	50 Hz	50 Hz
Rated power	1000 W	1400 W	1400 W	1800 W
No-load speed	3450 rpm	3000 rpm	3250 rpm	3250 rpm
Cutting width	320 mm	380 mm	380 mm	420 mm
Adjustable height position	25-45-65 (3 positions)	25-65 (5 positions)	25-75 (5 positions)	25-80 (5 positions)
Collection bag	25 l	50 l	40 l	40 l
Mulching function	-	-	-	+
Handles adjustment	-	-	+	+
Wheels front/rear	5,5"	6"/7"	6"/8"	6"/9"
Gross dimensions (L×W×H)	590x380×290 mm	660x440×335 mm	700x470×335 mm	720x470×365 mm
Net weight	6,8 kg	16,7 kg	11,6 kg	12,6 kg
Gross weight	8 kg	17,8 kg	13,8 kg	13,9 kg



## ELECTRIC BRUSH CUTTER & STRING TRIMMER

# ELECTRIC BRUSH CUTTER & STRING TRIMMER

The Könnert & Söhnen® electric brush cutter is the ideal solution for those looking for a reliable and powerful tool. It will help quickly and effectively tidy up the area without interruptions for recharging and refueling. Since the trimmer is used in a hanging position, rather than being placed on the ground, it is particularly convenient for property owners with uneven terrain, on slopes, or if there are a lot of obstacles or other plantings on the property.

Thanks to its high-performance 1400 W engine with a high speed of cutting knife up to 7,500 rpm and its adaptability, the Könnert & Söhnen® **electric trimmer** KS BCT-1400 will meet various user needs. It is equipped with two nozzles for work: a knife with three blades and a spool with a line. Additionally, it has the option of fitting a 255 mm (40 teeth) high-strength knife with tips made of an extra-hard material (optional). This trimmer can easily cope with the toughest shrubs, all kinds of weeds, reeds and even small trees. The top-mounted engine enables you to effectively cope even with very tall plants and use the tool for cutting wet grass.

### Rated power



1400 W

### Voltage



230 V/50 Hz

### Cutting width



420 mm

### No-load speed



7000 rpm

### ✓ EASY TO USE AND STORE

The ergonomic "T" design of the handle enables operation with both hands, extending the reach of the working area for efficient field processing. The shoulder strap with a soft padding helps balance the working weight, allowing you to work for long periods without fatigue. The "T" handle can be adjusted to different heights, adapting the trimmer to any user's stature. Additionally, they are easy to assemble and disassemble within minutes for convenient transport and compact storage.

### ✓ USER SAFETY

The accidental start lock button makes working with the trimmer safer and prevents the tool from unexpectedly turning on. A protective cover made of impact-resistant plastic covers the cutting nozzles, protects the user from ejected grass and other objects.

### ✓ TOOL PROTECTION

The electric trimmer is equipped with safety features to extend its service life. It is protected against overload, so you don't have to worry about the tool during prolonged use. If the engine temperature exceeds the working limits, the automatic protection system comes into action. For safety reasons, the electric cord has a short length to prevent it from being accidentally cut during operation.





### SOFT START

The soft start system eliminates the risk of jerks during the activation of the device, contributes to a more comfortable start of work, and also prevents excessive load on the engine, thereby extending its service life.

## KS BCT-1400

Rated voltage	<b>230 V</b>
Frequency	<b>50 Hz</b>
Rated power	<b>1400 W</b>
Rot. speed with trimmer head	<b>7000 rev/min</b>
The cut. Blade rot. Speed.	<b>up to 7500 rev/min</b>
Max cutting width	<b>420 mm</b>
Line length	<b>5 m</b>
Line diameter	<b>Ø1,6 mm</b>
Gross dimensions (L×W×H)	<b>940×260×130 mm</b>
Net weight	<b>4,5 kg</b>
Gross weight	<b>5,6 kg</b>

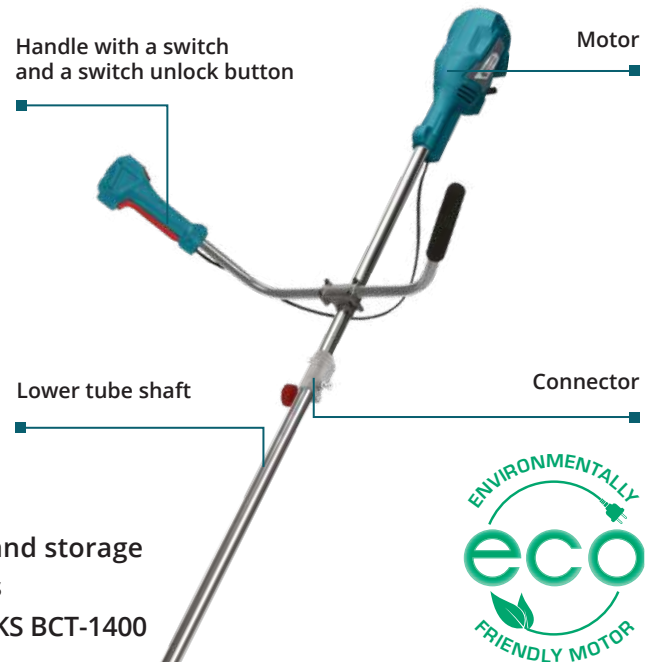

- ✓ The split shaft enables convenient transportation and storage
- ✓ Three tooth blade & trimming line for diverse tasks
- ✓ Possibility to install round disc (not in set) for model KS BCT-1400

#### ACCESSORIES IN A SET:

- Shoulder strap
- Three-tooth blade
- Line head with 5m trimming line
- A high-strength 255 mm disc (40 teeth) with carbide tips (optional)



## ELECTRIC PORTABLE TRIMMER

The portable electric trimmer KS GT-250 is an extremely compact and lightweight device, weighing only 1.22 kg, yet it has a high rotation speed of 12,000 rpm. It is designed for mowing soft, young grass within a small area. It is particularly effective for cutting grass in hard-to-reach areas such as path edges. The low position of the engine reduces vibration on the handle and ensures comfortable operation with the trimmer.

## KS GT-250

Rated voltage	<b>230 V</b>
Frequency	<b>50 Hz</b>
Rated power	<b>250 W</b>
No-load spool speed	<b>12000 rpm</b>
Max cutting width	<b>220 mm</b>
Line length	<b>6 m</b>
Line diameter	<b>Ø1,2 mm</b>
Gross dimensions (L×W×H)	<b>195×120×400 mm</b>
Net weight	<b>1,22 kg</b>
Gross weight	<b>1,46 kg</b>



# TILLERS

## ELECTRIC AND GASOLINE

A wide range of Köhner & Söhne® **tillers** to meet a variety of customer needs during gardening work: tilling the soil of varying hardness from loose to virgin clay, planting crops, hilling, and harvesting. These are practical and reliable multifunctional agricultural units.

Given their maneuverability in confined spaces, these compact electric tillers are ideal for small plots or greenhouses. Powerful gasoline tillers can handle heavy duty tasks on medium to large land plots.



TRADITIONS OF GERMAN QUALITY  
ARE AFFORDABLE FOR EVERYBODY!

**KÖNNER  
SÖHNEN**



≤ 36 – 134 cm



KÖNNER & SÖHNEN® TILLERS ARE SUITABLE FOR  
A VARIETY OF APPLICATIONS ON ALL SOIL TYPES,  
FROM LOOSE TO VIRGIN CLAY

TILLERS



# ELECTRIC TILLERS

Könner & Söhnen® **ECO-series electric cultivators** are excellent helpers and designed for tilling small areas. These devices can easily maneuver in conned spaces, for example, in greenhouses or areas of landscape design.

They are easy to operate, require no special skills, and can be used by all categories of users. Cultivators of this series are environmentally-friendly, low-noise, and require minimum maintenance.

### Engine power



1000-2000 W

### Voltage



230V

### Tilling width



≤ 36-55 CM

### Reduced noise level



Lpa (7m) - 68 dB

- Protection from accidental start
- Environmentally safe and almost silent electric motor K&S
- High maneuverability
- Ergonomic control panel with adjustable handles (for model KS 2000T E)

- Chain transmission transfers up to 95% of engine torque (for model KS 2000T E)
- A wheel for easy transportation (for models KS 1500T E, KS 2000T E)
- Optimal ratio of power to weight



3D REVIEW





Environmentally safe and almost silent electric motor K&S



**KS 1000T E**



**KS 1500T E**



**KS 2000T E**

Engine model	KS ECO 1000	KS ECO 1500	KS ECO 2000
Engine power, W	1000	1500	2000
Voltage, V	230	230	230
Frequency, Hz	50	50	50
Engine type	electric	electric	electric
Tilling width, cm	≤ 36	≤ 45	≤ 55
Max. tilling depth, cm	≤ 22	≤ 22	≤ 26
Noise level Lpa (7m)/Lwa, dB	68/93	68/93	68/93
Gross dimensions (LxWxH), mm	380x275x530	480x320x545	660x410x510
Net weight, kg	10	14,5	33,4
QR code			

ELECTRIC TILLERS



# GASOLINE TILLERS

## WITH BELT DRIVE

Könner & Söhnen® **belt-driven gasoline cultivators** with a power of **5 to 7 HP** are intended for processing all types of soils, from loose to virgin-clay. These belt-driven gasoline cultivators are practical, reliable and multifunctional agricultural units for solving multiple tasks, including preparation of soil of various hardness, planting of crops, harvesting, hilling. The unique, stylish design goes together with advanced technologies and compact dimensions. High-performance and fuel-efficient four-stroke cultivator engines from Könner & Söhnen® comply with the latest EURO 5 emission standard, are designed for continuous operation and provide high performance.

Compact models KS 4HP-70 and KS 7HP-850A are equipped with transport wheel that provide enhanced maneuverability even on small land plots. Models KS 7HP-850A, KS 7HP-950A and KS 7HP-950S are suitable for accommodating extra attachments (hilling-up plow, subsoil plow, potato digger, metal wheels with grousers).

### Engine power



5 - 7HP

### Gear



BELT DRIVE,  
CHAIN DRIVE

### Tilling width



≤ 50 - 108 CM



ARE SUITABLE FOR  
ACCOMMODATING  
ATTACHMENTS

Ergonomic control panel  
(handles are adjustable vertically  
by 180° and horizontally by 360°)

Powerful and reliable EURO 5  
engine of Könner & Söhnen®



Forged saber-shaped  
cutters with plant shields  
(suitable for any type of soil)

Toolbox  
(for model KS 7HP-950S)

Adjustable plow holder.  
The possibility of installing  
additional attachments

Transport wheel or support leg

Tubeless wheels with  
low profile rubber



3D REVIEW



WATCH THE VIDEO  
OF MACHINERY  
IN WORK





### POWERFUL ENGINES

High-performance and robust K&S engines meet all European quality standards, including the latest EURO 5 emission standard. Each engine has its own individual serial number, which allows us to control the quality of production and service.



### ERGONOMIC CONTROL PANEL

The ergonomic control panel allows you to quickly control and easily steer the cultivator. Cultivators have vertically and horizontally adjustable handles for convenient operation and compact storage, model KS 7HP-950S additionally equipped with a toolbox.



### FORGED CUTTERS

With forged saber-shaped cutters, the cultivator is suitable for any type of soil, both virgin and well-managed soil. They are supplied with protective shields (except for model KS 7HP-850A). The tilling width for such models is from 50 up to 108 cm, and the tilling depth is up to 31 cm.



### QUALITY IN DETAILS

All connections and fasteners are perfectly thought out, designed with a margin of safety for long-term and comfortable use of the cultivator. Damage-resistant elements, high-quality fittings, special rubber gaskets to reduce vibration and noise emission guarantee comfortable use of the cultivator.



# GASOLINE TILLERS



## KS 4HP-70

Engine power	5 hp
Engine type	gasoline
Tilling width	50-70 cm
Max. tilling depth	≤ 27 cm
Forward speed	1
Adjustable handles	vertically
Gross dimensions (LxWxH)	680x380x650 mm
Net weight	36 kg



## KS 7HP-850A

Engine power	7 hp
Engine type	gasoline
Tilling width	≤ 80 cm
Max. tilling depth	≤ 31 cm
Forward speed	+1 0
Adjustable handles	vertically
Gross dimensions (LxWxH)	690x380x770 mm
Net weight	52 kg



## KS 7HP-950A

Engine power	7 hp
Engine type	gasoline
Tilling width	≤ 108 cm
Max. tilling depth	≤ 31 cm
Forward speed	+2 +1 0 -1
Adjustable handles	vertically
Gross dimensions (LxWxH)	845x460x660 mm
Net weight	62 kg



## KS 7HP-950S

Engine power	7 hp
Engine type	gasoline
Tilling width	≤ 108 cm
Max. tilling depth	≤ 31 cm
Forward speed	+2 +1 0 -1
Adjustable handles	vertically/horizontally
Gross dimensions (LxWxH)	780x460x780 mm
Net weight	80 kg





## ATTACHMENTS

Belt-driven cultivator models KS 7HP-850A, KS 7HP-950A and KS 7HP-950S from Könnér & Söhnen®, as well as models with direct drive and gearbox are suitable for **accommodating attachments**. A wide range of attachments designed to process all types of soils to maximize customer satisfaction.

### Potato plough



#### KS PP4

Weight

4,5 kg



### Sided plough



#### KS SP2

Weight

4,2 kg



### Adjustable ditcher



#### KS AD3

Weight

4 kg



### Simple ditcher



#### KS SD1

Weight

2 kg



### Blade



#### KS BL10



### Pneumatic wheels



#### KS RW40

Diameter

4.00 - 8"

Weight

4 kg



### Metal grouser



#### KS MG40

Diameter

46,5 cm

Width

10 cm

Weight

3,3 kg



### Axle for wheel mounting



#### KS AT23

Diameter

23 cm

Length

20 cm

(for models KS 7HP-850A, KS 7HP-950A, KS 7HP-950S, KS 7HP-1050G, KS 9HP-1350G-3)





# GASOLINE TILLERS

## WITH GEARBOX

Könner & Söhnen® continues to improve **heavy-duty cultivator models** with gearboxes that can substitute more expensive diesel cultivators or even a one-axle mini-tractor. The existing range includes a model KS 9HP-1350G-3 with enlarged gearbox with three forward speeds and one reverse speed. In addition, the model has an active drive rear shaft function, which allows the use of equipment such as a motor pump or spray pump with a cultivator. Moreover, the model is suitable for accommodating a trailer for goods transportation. This model range has a tilling width of up to 134 cm!

The gearbox with gear drive makes the cultivators more reliable, durable and ready for heavy duty tasks. High-performance Könner & Söhnen® engines allow you to cope with tasks of any complexity and meet all European quality standards, including the latest EURO 5 emission standards.

### Engine power



7,0 - 9,0 HP

### Gear



BEVEL GEAR DRIVE

### Tilling width



≤ 50 - 134 CM



ARE SUITABLE FOR ACCOMMODATING ATTACHMENTS

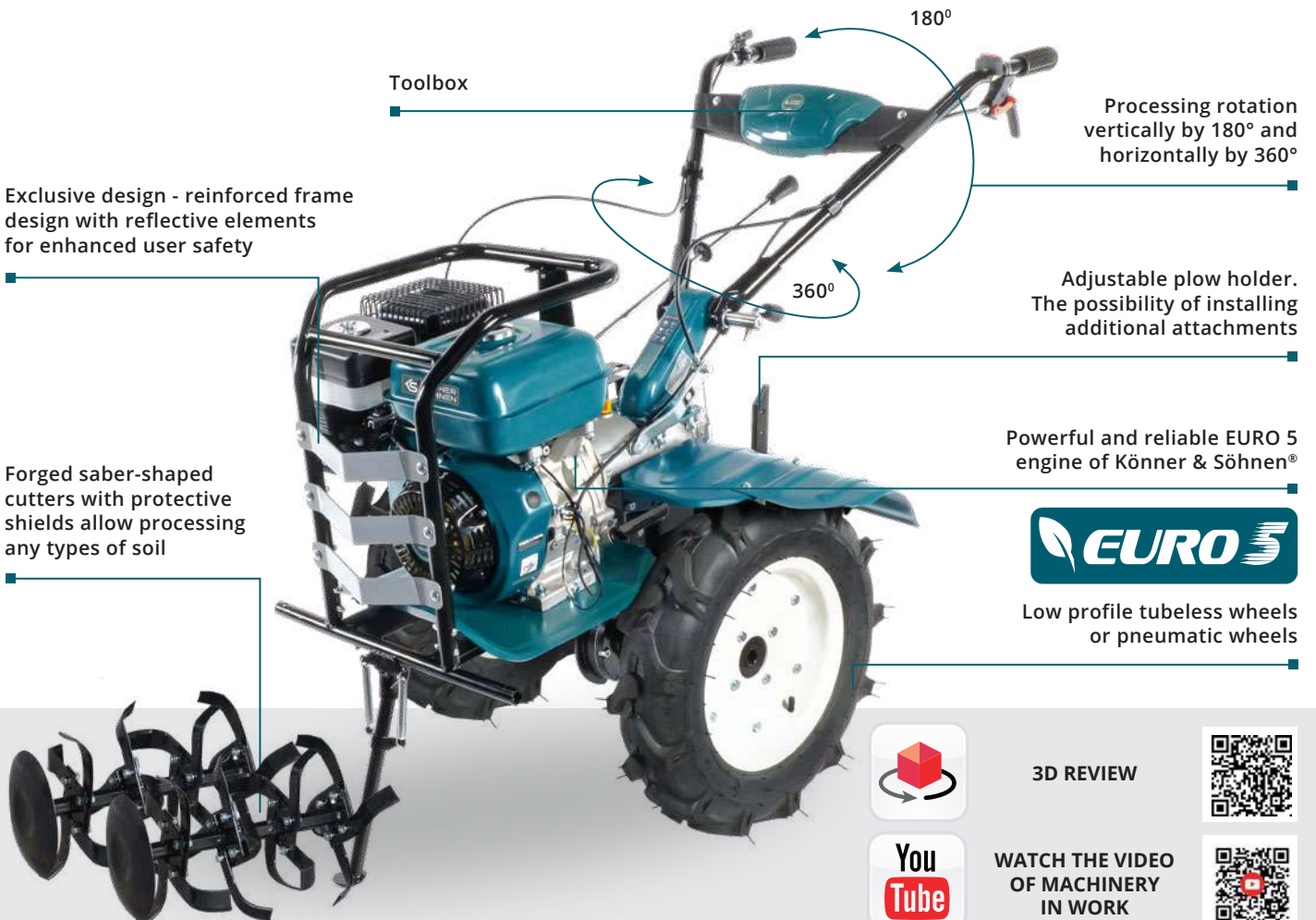

Low profile tubeless wheels or pneumatic wheels



3D REVIEW



WATCH THE VIDEO OF MACHINERY IN WORK





### POWERFUL ENGINES

Proprietary high-performance engines from Könnér & Söhnen have an increased lifespan. They are characterized by an easy start and reduced vibration. Each engine has its own individual serial number, which allows us to control the quality of production and service.



### TUBELESS OR PNEUMATIC WHEELS

These cultivator models are equipped with high-quality wheels. Model KS 7HP-1050G has low-profile tubeless rubber wheels, which require no pumping during operation. Cultivator model KS 9HP-1350G-3 in a set complete with high-quality pneumatic wheels with a diameter of 4,00-8" or 5,00-12".

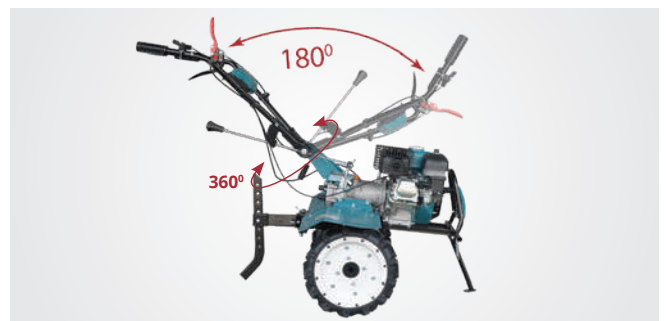

### ERGONOMIC CONTROL PANEL

The ergonomic control panel allows you to quickly control and easily steer the cultivator. The possibility of vertical adjustment of the handles by 180° and horizontal by 360° allows you to customize the cultivator for any user, provides easy control and convenient storage of the cultivator. The panel is equipped with a toolbox.

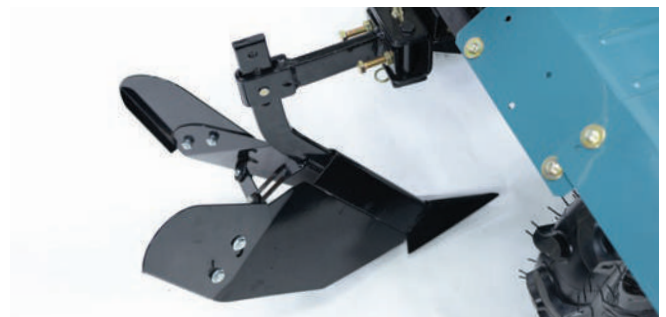

### ACCESSORIES

A wide range of attachments for a wide range of activities (planting of crops, harvesting, hilling, etc.) is suitable for processing all soil types to maximize customer satisfaction.



## KS 7HP-1050G

Engine power	7 hp
Engine type	gasoline
Tilling width	≤ 108 cm
Max. tilling depth	≤ 35 cm
Forward speed	+2 +1 0 -1
Adjustable handles	vertically/horizontally
Gross dimensions (LxWxH)	880x460x660 mm
Net weight	93 kg



## KS 9HP-1350G-3

Engine power	9 hp
Engine type	gasoline
Tilling width	≤ 134 cm
Max. tilling depth	≤ 35 cm
Forward speed	+3 +2 +1 0 -1
Adjustable handles	vertically/horizontally
Gross dimensions (LxWxH)	910x570x750 mm
Net weight	94 kg



## ATTACHMENTS

Belt-driven cultivator models KS 7HP-850A, KS 7HP-950A and KS 7HP-950S from Könnér & Söhnen®, as well as models with direct drive and gearbox are suitable for **accommodating attachments**. A wide range of attachments designed to process all types of soils to maximize customer satisfaction.

### Metal wheels

KS MW40	
Diameter	39,5 cm
Width	18,5 cm
Weight	8 kg



### Metal wheels

KS MW45	
Diameter	42 cm
Width	19,5 cm
Weight	8 kg



### Pneumatic wheels

KS RW50	
Diameter	5.00 - 12"
Weight	9,6 kg



### Weeding plough

KS DP1	
Weight	13 kg



### Adjustable plough

KS AP1	
Net/Gross weight	10,9/12,2 kg



### Weeding plough

KS WP1	
Net/Gross weight	7,6 / 8,3 kg

Weeding triple plough KS WP1 for weeding and loosening soil.





# GASOLINE TILLERS







KS 4HP-70

KS 7HP-850A

KS 7HP-950A

KS 7HP-950S

Engine model	KS 160	KS 240	KS 240	KS 240
Engine power, hp	5	7	7	7
Engine volume, cm <sup>3</sup>	173	212	212	212
Engine type	gasoline	gasoline	gasoline	gasoline
Tilling width, cm	50-70	≤ 80	≤ 108	≤ 108
Max. tilling depth, cm	≤ 27	≤ 31	≤ 31	≤ 31
Fuel tank volume, l	1,5	3,6	3,6	3,6
Crank case volume, l	0,6	0,6	0,6	0,6
Transmission case volume, l	0,1	-	1,2	1,2
Gear	belt drive, worm drive	belt drive, chain drive		
Forward speed	1	+1 0	+2 +1 0 -1	+2 +1 0 -1
Reverse	-	-	+	+
Adjustable handles	vertically	vertically	vertically	vertically, horizontally
Wheels	transport wheel	transport wheel	transport wheel, possibility to complete set with additional pneumatic wheels	tubeless wheels with low profile rubber
Noise level Lpa (7 m)/Lwa, dB	68/93	73/98	73/98	73/98
Gross dimensions (LxWxH), mm	680x380x650	690x380x770	845x460x660	780x460x780
Net weight, kg	36	52	62	80
Gross weight, kg	40	56	71	89
QR code				



Könnert & Söhne® engines are reliable, high-performance and cost-effective, and conform to European quality standards, including the latest **standard of emission EURO 5**



KS 7HP-1050G



KS 9HP-1350G-3

Engine model	KS 240	KS 290
Engine power, hp	7	9
Engine volume, cm <sup>3</sup>	212	270
Engine type	gasoline	gasoline
Tilling width, cm	≤ 108	≤ 134
Max. tilling depth, cm	≤ 35	≤ 35
Fuel tank volume, l	3,6	6,0
Crank case volume, l	0,6	1,1
Transmission case volume, l	1,2	1,5
Gear	direct drive with gearbox	
Forward speed	+2 +1 0 -1	+3 +2 +1 0 -1
Reverse	+	+
Adjustable handles	vertically, horizontally	vertically, horizontally
Wheels	low-profile tubeless wheels 4.00-10"	pneumatic wheels 4.00-8" or 5.00-12"
Noise level Lpa (7 m)/Lwa, dB	73/98	73/98
Gross dimensions (LxWxH), mm	910x460x690	910x570x750
Net weight, kg	83	94
Gross weight, kg	92	110
QR code		



Könnner & Söhnen® engines are reliable, high-performance and cost-effective, and conform to European quality standards, including the latest **standard of emission EURO 5**



# ALL-WEATHER MULTIFUNCTION MACHINE 4 IN 1

This **high-performance machine** combines multiple functions for agricultural work throughout the year. The outstanding feature of this machine is self-propelled capacity and active attachments, which eliminate the need for extra user effort and allow the machine to cope with a wide range of tasks.

A variety of attachments mounted on the motor block of the multifunction machine can be used for such works as cleaning snow, dust, dirt, fallen leaves or other debris. A machine with such features will be useful not only in a private house with a backyard, a country house, but also for hotel facilities, suburban guest houses, garden societies, etc.

## 5 KEY ADVANTAGES of Könnert & Söhnen multifunction machine:

- ✓ **COST SAVER** - No need to buy separate units
- ✓ **TIME SAVER** - Attachments can be changed in seconds without additional tools and special skills
- ✓ **EFFORT SAVER** - No need to assemble and disassemble various units, just replace the attachment
- ✓ **OPERATION AND MAINTENANCE SAVER** - No need to refuel and maintain various units
- ✓ **STORAGE SPACE SAVER** - With compact design, the machine takes up space of only one item and is used all year round rather than standing idle most of the year



**4 IN 1  
INDISPENSABLE ASSISTANT  
AT ANY TIME OF THE YEAR**

### MANEUVERABILITY AND VERSATILITY

Compact size and small angle of turn provide versatility and increased maneuverability of this model with the entire range of attachments even in confined spaces

### INCREASED NUMBER OF GEARS

The number of gears (5 forward and 2 reverse gears) enables to choose the optimal speed for each job

### QUALITY IN DETAILS

All connections and fasteners are perfectly thought out and designed with a safety margin for long-lasting and reliable operation of the machine

### PROPRIETARY K&S ENGINE

Reliable, robust and heavy-load 6,5 HP K&S gasoline engine meets the latest EURO 5 emission standard



### MAXIMUM PRODUCTIVITY

A direct drive transmission has increased power and ensures better performance with each attachment

### ALL-SEASON HIGH-TREAD TIRES

Wide wheels 13\*4.1-6 with all-season high-tread tires provide excellent ground and snow passability



WATCH THE VIDEO  
OF MACHINERY  
IN WORK







**4 IN 1  
INDISPENSABLE ASSISTANT  
AT ANY TIME OF THE YEAR**



MULTIFUNCTION MACHINE



**Multifunction machine**

**KS 7HP-MFM 60**

**Multifunction machine**

**KS 7HP-MFM 80E**

Drive	<b>direct</b>	<b>direct</b>
Engine model	<b>KS 220</b>	<b>KS 220</b>
Engine type	<b>gasoline</b>	<b>gasoline</b>
Engine power	<b>6,5 hp</b>	<b>6,5 hp</b>
Engine start	<b>manual</b>	<b>manual/electric</b>
Fuel tank volume	<b>3,6 l</b>	<b>3,6 l</b>
Fuel consumption*	<b>1,2 - 1,8 l/h</b>	<b>1,2 - 1,8 l/h</b>
Net weight	<b>72 kg</b>	<b>78 kg</b>
Gross weight	<b>80 kg</b>	<b>88 kg</b>

\*Fuel consumption depends on many factors, such as load, fuel quality, season, altitude, technical condition of the machine.



# ALL-WEATHER MULTIFUNCTION MACHINE 4 IN 1

The **sweeper attachment** for the Könnér & Söhnen® multifunction machine is a universal item for all-year-round use. It will quickly and effectively cope with dust, dirt, fallen leaves, and snow drifts. It is an indispensable helper in maintaining perfect cleanliness in the yard, on driveways to houses and garages, as well as on walkways in parks, squares and other surrounding areas.

- ✓ **Top-notch hard bristles**
- ✓ **Adjustable angle of turning for easy cleaning**

## SWEEPER

<b>KS 7HP-MFM 60</b> <b>KS 7HP-MFM 80E</b>				
Brush diameter	<b>345 mm</b>			
Working width	<b>60/80 cm</b>			
Adjustable angle of turning	<b>± 15°</b>			
Brush speed	<b>255 rpm</b>			
Gross dimensions (60/80 cm)	<b>620/820x570x420 mm</b>			
Net weight (60/80 cm)	<b>32/35 kg</b>			
Gross weight (60/80 cm)	<b>38/43 kg</b>			



The **dust box attachment** for the Könnér & Söhnen® sweeper serves to collect litter and protects against throw-off of debris during high-speed cleaning.

- ✓ **Capacious dust box for dust and debris**
- ✓ **High maneuverability thanks to 360-degree wheels**

## DUST BOX

<b>KS MFM-DB 60</b> <b>KS MFM-DB 80</b>				
Working width	<b>60/80 cm</b>			
Gross dimensions (60/80 cm)	<b>630/830x390x335 mm</b>			
Net weight (60/80 cm)	<b>6,6/8,5 kg</b>			
Gross weight (60/80 cm)	<b>8,5/10 kg</b>			



## ADDITIONAL ACCESSORIES

A set of spare brushes for a wide range of cleaning work throughout the year. Suitable for KS 7HP-MFM 80E and KS 7HP-MFM 60 sweepers. They handle dust, dirt, fallen leaves and snow drifts quickly and efficiently.

### SET OF SPARE BRUSHES

<b>KS MFM BK 80/26</b>			
Gross dimensions (60/80 cm)	<b>360x360x340 mm</b>		
Net weight (60/80 cm)	<b>4,96 kg</b>		
Gross weight (60/80 cm)	<b>5,88 kg</b>		



The active **snow blower attachment** for the Könnér & Söhnen® multifunction machine with a powerful gear auger will quickly cope with large snow drifts and blockages, with any type of snow.

- ✓ Sharp serrated edges can cope even with stale snow
- ✓ Reinforced bucket with stiffeners
- ✓ Shovel for cleaning a chute and screw from snow in a set

## SNOW BLOWER

### KS MFM-SB 60



Chute turning radius	270°
Snow throwing range	0-10 m
Gross dimensions	600x470x470 mm
Net weight	21 kg
Gross weight	23 kg



MULTIFUNCTION MACHINE

The **snow pusher attachment** is designed not only for removing of snow and other bulk materials, but also for cutting and leveling the soil.

- ✓ It has grips for easy handling

## SNOW SHOVEL

### KS MFM-SS 60 KS MFM-SS 80



Working width	60/80 cm
Gross dimensions (60/80 cm)	620/820x465x110 mm
Net weight (60/80 cm)	6,6/7,7 kg
Gross weight (60/80 cm)	8,8/9,8 kg

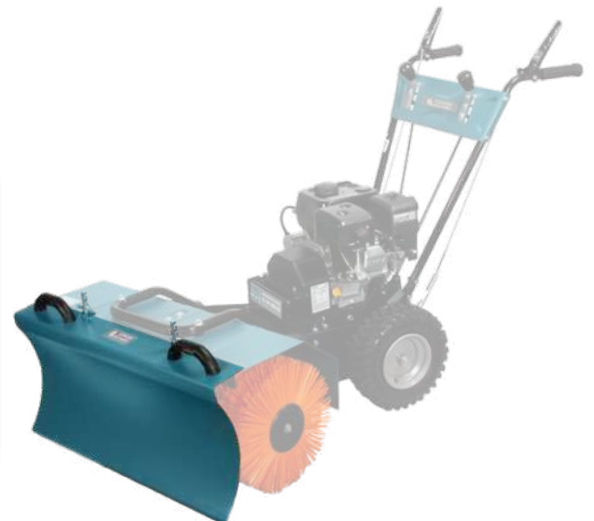

## ADDITIONAL ACCESSORIES

### ANTI-SKID CHAIN

#### KS MFM SC 13/4.1



Net weight (60/80 cm)	2,18 kg
-----------------------	---------

### PNEUMATIC WHEELS

#### KS MFM RW 13/4.1



Wheel size	13*4.1-6
------------	----------

### LED LAMP

#### KS MFM LAMP



Net weight (60/80 cm)	0,16 kg
-----------------------	---------



# LOG SPLITTERS

## AND WOOD CHIPPERS

Woodworking equipment from Könnert & Söhne® includes electric and gasoline wood splitters, with splitting force **from 7 to 27 tons**, as well as wood shredders with a capacity of **6,5 to 15 hp**. It is reliable and durable machinery for natural wood processing or wood waste.

Cleaning in the garden, in the yard or harvesting firewood can cause significant inconvenience, require a lot of time and effort. Garden shredders and wood splitters, presented in the assortment Könnert & Söhne®, can easily handle this task. Secondary processing of waste will help you not only save your own funds, but also to preserve natural resources.

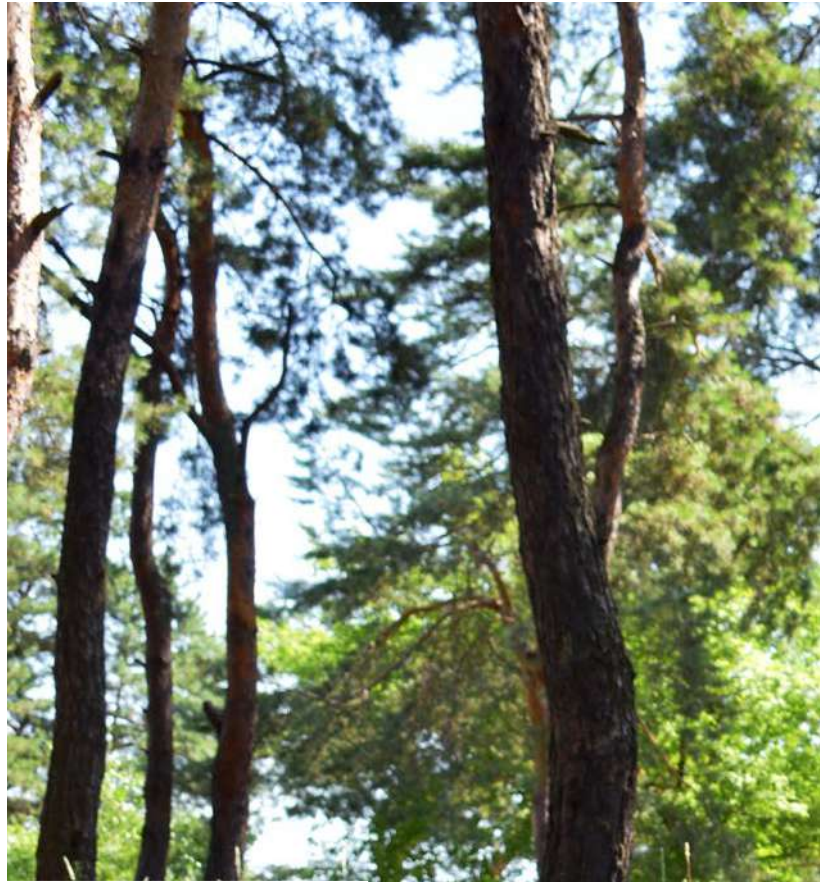

TRADITIONS OF GERMAN QUALITY  
ARE AFFORDABLE FOR EVERYBODY!

**KÖNNER  
SÖHNEN**

 **7 T – 27 T**



LOG SPLITTERS

RELIABLE KÖNNER & SÖHNEN® UNITS EFFICIENTLY PROCESS ANY TYPES OF WOOD FROM DRY MATERIAL TO FRESH WOOD, PROVIDING MAXIMUM PRODUCTIVITY AND COMFORT OF USE

# ELECTRIC AND GASOLINE LOG SPLITTERS

Dimax Int. GmbH (Germany) introduces **electric and gasoline log splitters** from Könnert & Söhne®. Our model range includes both hydraulic and kinetic log splitters. The use of powerful motors in combination with high-quality components allows splitting a large number of logs, both very dry and wet, with a log diameter ranging from 300 to 550 mm and the maximum splitting length reaching 650 mm. These units are suitable for both private and commercial use.

Kinetic log splitters from Könnert & Söhne® are high-performance machines with a cutting time of about 2 seconds. They are thus 5-7 times faster than hydraulic log splitters. To split a log, you just need to raise the lever and allow the log splitter to do the rest of the job for you. Smooth operation of hydraulic log splitters allows safe splitting of logs. Könnert & Söhne® log splitters ensure quick and easy splitting of a large number of logs.

Splitting force



7-27 TON

Max. splitting length



520 - 650 mm

Engine type

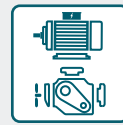

ELECTRIC/GASOLINE

Max. splitting diameter



300 - 550 mm

Protective metal grill

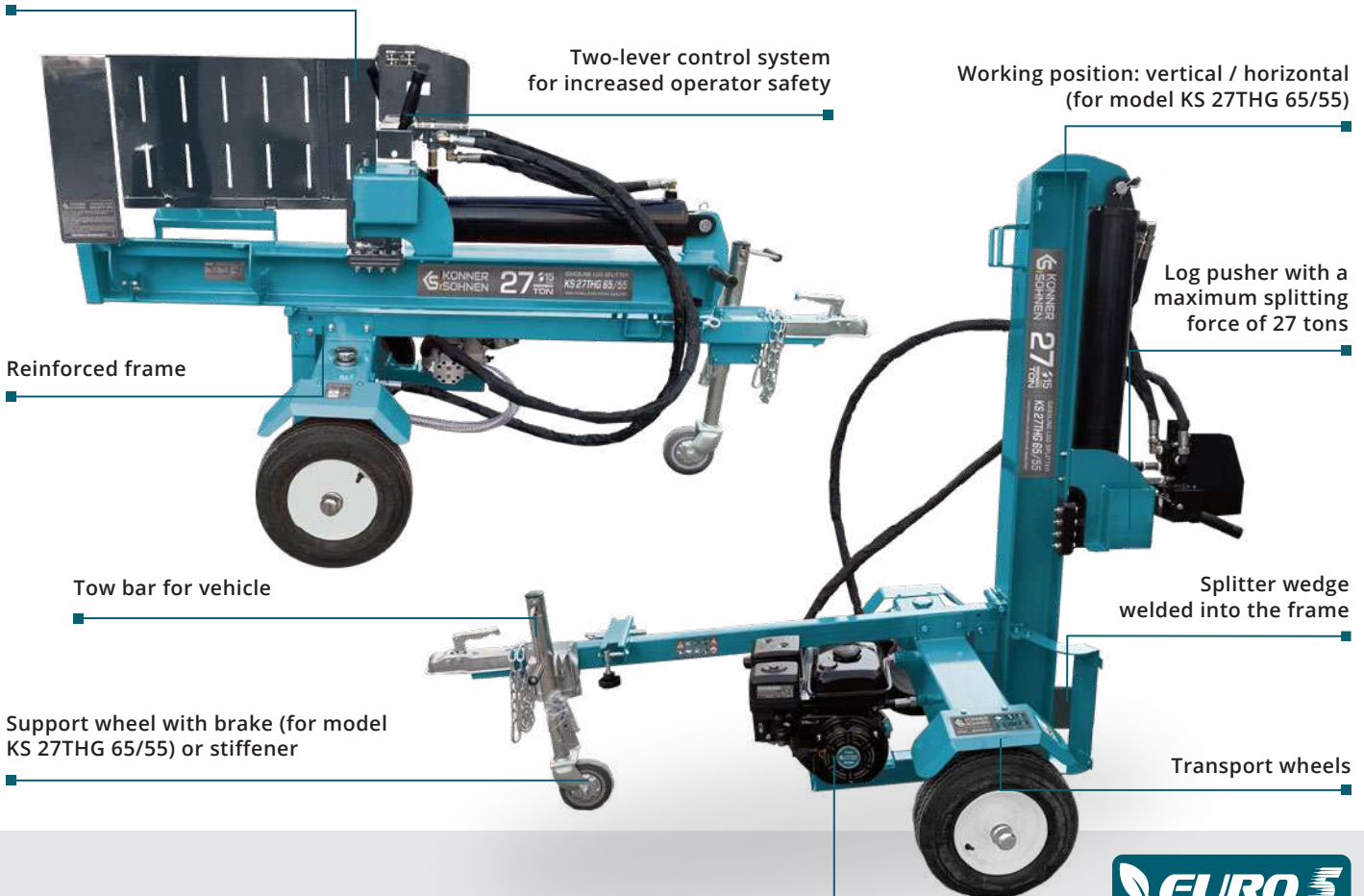

Reinforced frame

Tow bar for vehicle

Support wheel with brake (for model KS 27THG 65/55) or stiffener

Two-lever control system for increased operator safety

Working position: vertical / horizontal (for model KS 27THG 65/55)

Log pusher with a maximum splitting force of 27 tons

Splitter wedge welded into the frame

Transport wheels



WATCH THE VIDEO OF MACHINERY IN WORK



Powerful and reliable EURO 5 engine of Könnert & Söhne®

## GASOLINE LOG SPLITTERS

Könnér & Söhnen® **gasoline log splitters** are characterized by high power, resistance to moisture and temperature drops. These highly mobile and mains-independent machines are equipped with a cutting-edge engine that meets all European quality standards, including the EURO 5 emission standard.

✔ Könnér & Söhnen kinetic log splitters are outstanding time savers, as the splitting capacity depends on how quickly you can feed logs for splitting.

<b>KS 15TKG 52/35</b>	
Log splitter type	<b>kinetic</b>
Engine power	<b>6,5 hp</b>
Splitting force	<b>15 ton</b>
Engine type	<b>gasoline</b>
Max. splitting length	<b>520 mm</b>
Max. splitting diameter	<b>350 mm</b>
Cutting time	<b>~ 2 sec.</b>
Working position	<b>horizontal</b>
Wheels	<b>12"</b>
Gross dimensions (LxWxH)	<b>1400x380x610 mm</b>
Net weight	<b>97 kg</b>



LOG SPLITTERS

✔ The powerful and high-performance KS 27THG 65/55 hydraulic log splitter with a splitting force of 27 tons combines the capabilities of horizontal and vertical automated processes, which is especially suitable for splitting large logs. There is no need to lift heavy logs high.

<b>KS 27THG 65/55</b>	
Log splitter type	<b>hydraulic</b>
Engine power	<b>6,5 hp</b>
Splitting force	<b>27 ton</b>
Engine type	<b>gasoline</b>
Max. splitting length	<b>650 mm</b>
Max. splitting diameter	<b>550 mm</b>
Cutting time	<b>~ 15 sec.</b>
Working position	<b>vertical/horizontal</b>
Wheels	<b>16"*4.8-8, support wheel with brake</b>
Gross dimensions (LxWxH)	<b>2250x505x570 mm</b>
Net weight	<b>260 kg</b>



Log splitters come complete with protective shield, gloves and protective metal grill.

# ELECTRIC LOG SPLITTERS

## ELECTRIC LOG SPLITTERS

**Electric log splitters** from Könnert & Söhnen® are compact and mobile devices equipped with a robust 2000 W engine. They are easy to operate, environmentally friendly and can be operated even indoors. They do not require complex maintenance or refueling, produce no exhaust gases and are easy to clean.

✔ **Compact and mobile Könnert & Söhnen® electric log splitters are easy to operate, transport and store. Smooth operation allows safe splitting of logs, so that you have plenty of time to put in another log.**

<b>KS 7THE 52/30</b>	
Log splitter type	<b>hydraulic</b>
Engine power	<b>2000 W</b>
Splitting force	<b>7 ton</b>
Engine type	<b>electric</b>
Max. splitting length	<b>520 mm</b>
Max. splitting diameter	<b>300 mm</b>
Cutting time	<b>~ 10 sec.</b>
Working position	<b>horizontal</b>
Wheels	<b>6"</b>
Gross dimensions (LxWxH)	<b>980x270x520 mm</b>
Net weight	<b>47 kg</b>



✔ **Driven by an electric motor, the flywheel of the Könnert & Söhnen electric log splitter accumulates enormous kinetic energy allowing an operator to quickly and easily split a large number of logs.**

<b>KS 8TKE 52/35</b>	
Log splitter type	<b>kinetic</b>
Engine power	<b>2000 W</b>
Splitting force	<b>8 ton</b>
Engine type	<b>electric</b>
Max. splitting length	<b>520 mm</b>
Max. splitting diameter	<b>350 mm</b>
Cutting time	<b>~ 2 sec.</b>
Working position	<b>horizontal</b>
Wheels	<b>8"</b>
Gross dimensions (LxWxH)	<b>1270x340x780 mm</b>
Net weight	<b>110 kg</b>



Log splitters come complete with protective shield, gloves and protective metal grill.



## VERTICAL ELECTRIC LOG SPLITTERS

Könner & Söhnen® **vertical log splitters** are high-performance units designed for heavy-duty applications. They feature a reliable electric motor and a hydraulic drive. All nodes are adapted to work for a long time without interruption in an intensive mode. The massive structure of the log splitter features transport wheels for easy handling and does not take up much storage space.

✔ The electric log splitter **KS 8THE V 55/40** from Könner & Söhnen easily handles any type of wood, has maximum performance and durability.

<b>KS 8THE V 55/40</b>	
Log splitter type	<b>hydraulic</b>
Engine power	<b>2300 W</b>
Splitting force	<b>8 ton</b>
Engine type	<b>electric</b>
Max. splitting length	<b>550 mm</b>
Max. splitting diameter	<b>400 mm</b>
Cutting time	<b>~ 15 sec.</b>
Working position	<b>vertical</b>
Wheels	<b>8"</b>
Gross dimensions (LxWxH)	<b>570x380x1160 mm</b>
Net weight	<b>114 kg</b>



LOG SPLITTERS

✔ The massive construction of the electric log splitter **KS 12THE V 65/40** from Könner & Söhnen has greater stability and a reduced level of vibration feedback due to the large base area. The lower position of the splitter wedge eliminates the need to lift the logs high for splitting.

<b>KS 12THE V 65/40</b>	
Log splitter type	<b>hydraulic</b>
Engine power	<b>2300 W</b>
Splitting force	<b>12 ton</b>
Engine type	<b>electric</b>
Max. splitting length	<b>650 mm</b>
Max. splitting diameter	<b>400 mm</b>
Cutting time	<b>~ 25 sec.</b>
Working position	<b>vertical</b>
Wheels	<b>8"</b>
Gross dimensions (LxWxH)	<b>710x450x1170 mm</b>
Net weight	<b>110 kg</b>

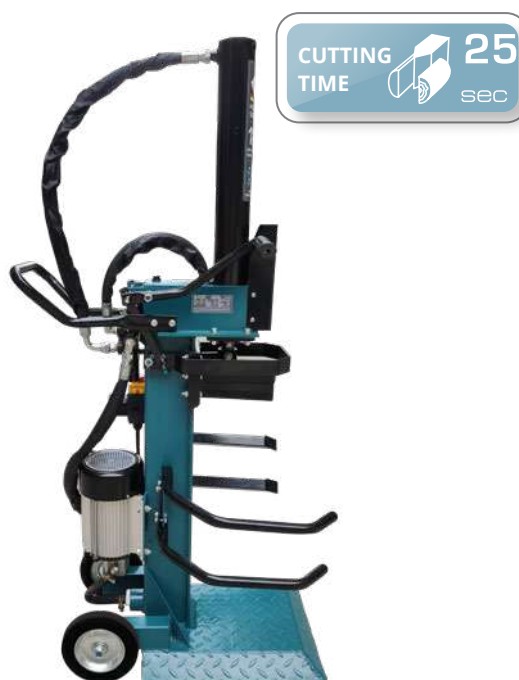

Log splitters come complete with protective shield, gloves and protective metal grill.

# ELECTRIC AND GASOLINE LOG SPLITTERS





**KS 7THE 52/30**



**KS 8TKE 52/35**



**KS 15TKG 52/35**

Engine type	electric	electric	gasoline
Log splitter type	hydraulic	kinetic	kinetic
Voltage, V	230	230	-
Frequency, Hz	50	50	-
Engine power	2000 W	2000 W	6,5 hp
Splitting force, ton	7	8	15
Max. splitting length, mm	520	520	520
Max. splitting diameter, mm	300	350	350
Cutting time, sec.	~ 10	~ 2	~ 2
Working position	horizontal	horizontal	horizontal
Flywheel rotation speed, rpm	-	400	450
Winding type	copper	copper	-
Wheels	6"	8"	12"
Gross dimensions (WxLxH), mm	980x270x520	1270x340x780	1400x380x610
Net weight, kg	47	110	97
Gross weight, kg	49	130	110
Protection class	IP54M	IP54M	IP54M
QR code			



## ADDITIONAL ACCESSORIES



**K&S SUPPORT BRACKET**



**TABLE FOR LOG SPLITTER**



**TREE FELLING LEVER**

KS 7THE 52/30	KS Bracket	-	KS Lever
KS 8TKE 52/35	-	KS 8-15Table	KS Lever
KS 15TKG 52/35	-	KS 8-15Table	KS Lever
KS 27THG 65/55	-	KS 27Table	KS Lever
KS 8THE V 55/40	-	-	KS Lever
KS 12THE V 65/40	-	-	KS Lever



Könner & Söhnen® engines are reliable, high-performance and cost-effective, and conform to European quality standards, including the latest **standard of emission EURO 5**



KS 8THE V 55/40



KS 12THE V 65/40



KS 27THG 65/55

Engine type	electric	electric	gasoline
Log splitter type	hydraulic	hydraulic	hydraulic
Voltage, V	230	230	-
Frequency, Hz	50	50	-
Engine power	2300 W	2300 W	6,5 hp
Splitting force, ton	8	12	27
Max. splitting length, mm	550	650	650
Max. splitting diameter, mm	400	400	550
Cutting time, sec.	~ 15	~ 25	~ 15
Working position	vertical	vertical	vertical/horizontal
Wheels	8"	8"	16"*4.8-8, support wheel with brake
Gross dimensions (WxLxH), mm	570x380x1160	710x450x1170	2250x505x570
Net weight, kg	114	110	260
Gross weight, kg	126	123	295
Protection class	IP54M	IP54M	IP54M
QR code			



Könnér & Söhnen® engines are reliable, high-performance and cost-effective, and conform to European quality standards, including the latest **standard of emission EURO 5**



# WOOD CHIPPERS SHREDDERS

Dimax Int. GmbH (Germany) expands the range of garden equipment and proudly presents highly mobile and mains-independent **gasoline wood chippers shredders** from Könnert & Söhnen®. These units are often used in private country houses, in the field, vineyards and gardens of large size, and useful for utilities during cleaning of parks, squares, etc.

Removing dry tree branches and pruning shrubs can create tons of waste, and burning such waste is prohibited by law as it poses a threat not only to human health, but also to the environment. Using a shredder will easily solve this problem. Waste recycling will not only save your money, but also conserve natural resources.

### Engine power



6,5 – 15 HP

### Chip ejection height



1100 – 1600 MM

### Engine start



MANUAL/ELECTRIC

### Blade

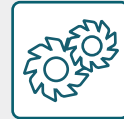

2 STEEL BLADES

### MAXIMUM SAFETY AND COMFORTABLE USE ARE GUARANTEED BY:

- a large feeding hopper, which enables easy feeding of branches into the machine and their easy shredding;
- a silicone cover located on the inlet, which prevents ejection of the material being shredded from the feeder side;
- a protective kit (polycarbonate protective shield, safety gloves, earmuffs) included in the scope of supply.

**WASTE RECYCLING  
SAVES NATURAL  
RESOURCES**



Outlet hopper with adjustable ejection height

Large feed hopper for easy feeding of material to be shredded

High-performance and reliable K&S engine meets all European quality standards, including EURO 5



Emergency stop button (for model KS 700WS)

Powerful cutting mechanism shreds wood waste up to 120 mm in total diameter

Robust, stable frame structure

Stability and maneuverability thanks to the low-lying center of gravity

Tow bar for vehicle

Pneumatic wheels for easy transport



WATCH THE VIDEO OF MACHINERY IN WORK



Gasoline wood chippers shredders from Könnér & Söhnen® are designed for chipping/shredding various industrial wood waste and garden plant waste (branches, vines, bark, etc.) into re wood chips or industrial chips of 3-20 mm in size. The resulting chips can be used as heating fuel in solid fuel and pyrolysis boilers, replaces, furnaces and other heating devices. In addition, chips can be used as a mulching material for plants.

Wood chippers shredders are equipped with high-speed hardened carbon steel blades that can process all types of wood and other plant waste from dry material up to fresh wood waste up to 120 mm in diameter.



WOOD CHIPPERS SHREDDERS

✔ **TWO HIGH-SPEED HARDENED CARBON STEEL BLADES**

Effectively process all types of wood and other plant waste from dry material up to fresh wood waste up to 120 mm in total diameter.

✔ **ROBUST AND PROPRIETARY ENGINE**

Cutting edge gasoline engines meet all European quality standards, including EURO 5.

✔ **MANEUVERABILITY IN TRANSPORTATION AND STABILITY IN USE**

The machine's low center of gravity makes this device stable and easy to maneuver despite its weight.

✔ **EASY MOVEMENT**

Shredders are equipped with pneumatic wheels for easy movement even on uneven surfaces, for example, on gravel or soil.

✔ **HIGH-PERFORMANCE MODEL**

The massive structure of the KS 700WS wood chipper shredder and the extremely efficient 420 cm<sup>3</sup> 15 hp engine make this device extremely reliable, robust, durable and ready for continuous use.



# WOOD CHIPPERS SHREDDERS



## KS 400WS

Engine power	<b>6,5 hp</b>
Engine start	<b>manual</b>
Number of cutting blades	<b>2 pc.</b>
Max total diameter (for upper hopper)	<b>76 mm</b>
One branch diameter (for upper hopper)	<b>10 mm</b>
Max total diameter (for side cone)	<b>76 mm</b>
One branch diameter (for side cone)	<b>45 mm</b>
Shredded chip size	<b>3-4 mm</b>
Wheels	<b>10"</b>
Net dimensions (LxWxH)	<b>750x480x1150 mm</b>
Net weight	<b>70 kg</b>



## KS 500WS

Engine power	<b>6,5 hp</b>
Engine start	<b>manual</b>
Number of cutting blades	<b>2 pc.</b>
Max total diameter (for upper hopper)	<b>76 mm</b>
One branch diameter (for upper hopper)	<b>30 mm</b>
Chip ejection height	<b>1100 mm</b>
Shredded chip size	<b>10-15 mm</b>
Wheels	<b>12"</b>
Net dimensions (LxWxH)	<b>1500x740x1300 mm</b>
Net weight	<b>95 kg</b>



## KS 700WS

Engine power	<b>15 hp</b>
Engine start	<b>manual/electric</b>
Number of cutting blades	<b>2 pc.</b>
Max total diameter (for upper hopper)	<b>120 mm</b>
One branch diameter (for upper hopper)	<b>50 mm</b>
Chip ejection height	<b>1600 mm</b>
Shredded chip size	<b>10-20 mm</b>
Wheels	<b>16"</b>
Net dimensions (LxWxH)	<b>2550x1100x1600 mm</b>
Net weight	<b>210 kg</b>



Wood chippers shredders come complete with polycarbonate protective shield, gloves, and earmuffs.



KS 400WS



KS 500WS



KS 700WS

Engine power, hp	6,5	6,5	15
Engine start	manual	manual	manual/electric
Number of cutting blades, pc.	2	2	2
Max total diameter (for upper hopper), mm	76	76	120
One branch diameter (for upper hopper), mm	10	30	50
Max total diameter (for side cone), mm	76	-	-
One branch diameter (for side cone), mm	45	-	-
Chip ejection height, mm	-	1100	1600
Shredded chip size, mm	3-4	10-15	10-20
Max. Blade Speed, rpm	2400	3000	3000
Engine type	gasoline 4-stroke	gasoline 4-stroke	gasoline 4-stroke
Engine cylinder volume, cm <sup>3</sup>	196	196	420
Engine model	KS 230	KS 230	KS 430
Engine speed, rpm	3600	3600	3600
Fuel tank volume, l	3,6	3,6	6,5
Crank case volume, l	0,6	0,6	1,1
Wheels	10"	12"	16"
Net dimensions (LxWxH), mm	920x730x1275	1500x740x1300	2550x1100x1600
Gross dimensions (LxWxH), mm	750x480x1150	880x480x760	1140x660x1120
Net weight, kg	70	95	210
Gross weight, kg	80	110	230
Protection class	IP54M	IP54M	IP54M
QR code			



Könner & Söhner® engines are reliable, high-performance and cost-effective, and conform to European quality standards, including the latest **standard of emission EURO 5**

# WATER PUMPS

## HIGHLY PRODUCTIVE

Könner & Söhne® **gasoline water pumps** are autonomous, mobile and high-performance devices. Strong and stable construction of motor pump ensures fast and productive pumping of water in significant volumes where it can not be done manually. Such units are capable in the shortest possible time drain a flooded basement or cope with a burst sewer.

It can be used for removing of trash water and impurities, for can be drained using a motor pump small bodies of water, transport clean water, supply it to fire stations and fight the fire directly.





 **20m – 50m**



WATER PUMPS

**KÖNNER & SÖHNEN® WATER PUMPS ARE HIGH-PERFORMANCE RELIABLE UNITS. ASSORTMENT OF WATER PUMPS INCLUDES MODELS FOR A WIDE RANGE WORKS, WHICH REQUIRE LIQUID PUMPING**

# WATER PUMPS

Dimax Int. GmbH (Germany) presents a range of Könnert & Söhne® water pumps with multiple applications: models for heavily contaminated water and aggressive liquids (sea water, chemicals) as well as upgraded existing models. All Könnert & Söhne® water pumps now feature a reinforced steel frame for heavy-duty operations, increased service life and more powerful engines.

Motor pumps from Könnert & Söhne® are perfect for country houses, cottages, plots where there is a need for pumping water: pumping it out of basements and wells, draining flooded areas, watering fields, etc. They require no power supply and therefore can be used in places remote from stationary outlets.

## Max lifting height



20 M-50 M

## Reinforced steel frame



Ø 28 MM

## Engine start



MANUAL

## Engine power



6,5-9,0 HP

In the new season, we have updated the range of existing motor pumps and added new models:

- ✓ For clean water
- ✓ For mud and trash water
- ✓ For aggressive liquids (sea water, chemicals)



Steel frame Ø 28 mm

Additional protective grill to prevent burns

Wide suction orifice

Strong housing

Reinforced frame construction for Heavy Duty tasks



Powerful and economic EURO 5 engine of Könnert & Söhne®



3D REVIEW





### RELIABLE BRANDED ENGINES

The engines used in the pumps Könnér & Söhnen® are manufactured under the strict control of German engineers, including the latest EURO 5 emission standard.



### INDIVIDUAL SERIAL NUMBER ON ENGINES

The proprietary robust K&S engine has its own individual serial number, which allows us to control the quality of production and service. Könnér & Söhnen engines are characterized by easy start and reduced vibration.



### EQUIPMENT

The fully molded housing of Könnér & Söhnen® motor pumps is made of high-strength aluminum; it is resistant to corrosion, temperature effects, and deformation. Könnér & Söhnen motor pumps are equipped with an enlarged steel fuel tank, which extends the operating time without additional refueling.



### DAMPERS TO LOWER VIBRATION

All models of the Könnér & Söhnen® pumps are equipped with rubber feet to reduce vibrations. Thanks to the rubber damper, the working pump will not damage the surface covering, and the frame coating will not be scratched.

WATER PUMPS



# WATER PUMPS

## CLEAN WATER MOTOR PUMPS

KS 50 and KS 80 **clean water motor pumps** of the German trademark Köhner & Söhne® are suitable not only for private use, but also for industrial facilities. These devices are often used for irrigation of land plots and fields, supply of drinking water, pumping water out of pools and flooded basements, elimination of consequences of accidents and flooding.

They are suitable for pumping slightly contaminated water with non-abrasive (soft) particles such as: particles of algae, grass, leaves, etc., with a concentration of up to 5% in the intake water and a size of up to 5 mm.



### KS 50

Type of water pump	<b>for clean water</b>
Diameter of inlet pipe	<b>50 mm</b>
Maximal productivity	<b>500 l/min</b>
Nominal speed	<b>3600 rpm</b>
Maximal height of lifting	<b>28 m</b>
Maximal depth of suction	<b>7 m</b>
Engine start	<b>manual</b>
Net dimensions (LxWxH)	<b>490x400x410 mm</b>
Net weight	<b>24 kg</b>



### KS 80

Type of water pump	<b>for clean water</b>
Diameter of inlet pipe	<b>80 mm</b>
Maximal productivity	<b>1000 l/min</b>
Nominal speed	<b>3600 rpm</b>
Maximal height of lifting	<b>28 m</b>
Maximal depth of suction	<b>7 m</b>
Engine start	<b>manual</b>
Net dimensions (LxWxH)	<b>490x400x410 mm</b>
Net weight	<b>26 kg</b>



## TRASH WATER MOTOR PUMP

The KS 80MW motor pump **for heavily contaminated water** from Könnér & Söhnen® is a high-performance device with a reinforced steel frame that is suitable for pumping large quantities of heavily contaminated liquids containing sewage residues sized up to 25 mm. Thanks to its robust design, the KS 80MW motor pump is suitable for heavy-duty operations, is perfect for pumping muddy water out of ponds, sewage water, cleaning rivers and lakes, and is successfully used for pumping waste water on drilling sites.



KS 80 MW	
Type of water pump	<b>for mud water</b>
Diameter of inlet pipe	<b>80 mm</b>
Maximal productivity	<b>1000 l/min</b>
Nominal speed	<b>3600 rpm</b>
Maximal height of lifting	<b>20 m</b>
Maximal depth of suction	<b>7 m</b>
Engine start	<b>manual</b>
Net dimensions (LxWxH)	<b>720x535x600 mm</b>
Net weight	<b>60 kg</b>



## MOTOR PUMP FOR HEAVILY CONTAMINATED WATER

The high-performance KS 80TW **waste water motor pump** from Könnér & Söhnen® is designed for pumping liquids containing up to 25% of solids sized up to 20 × 25 mm. The principal users of the KS 80TW trash water motor pumps are utility service providers, farm businesses and construction companies.



KS 80 TW	
Type of water pump	<b>for trash water</b>
Diameter of inlet pipe	<b>80 mm</b>
Maximal productivity	<b>1100 l/min</b>
Nominal speed	<b>3600 rpm</b>
Maximal height of lifting	<b>26 m</b>
Maximal depth of suction	<b>7 m</b>
Engine start	<b>manual</b>
Net dimensions (LxWxH)	<b>530x460x435 mm</b>
Net weight	<b>35 kg</b>





# WATER PUMPS

## MOTOR PUMP FOR AGGRESSIVE LIQUIDS (SEA WATER, CHEMICALS)

The KS 80CW motor pump **for aggressive liquids** from Könnert & Söhne® is intended for pumping sea water, weak acids, liquids with high flash point. It can be used in agriculture for fertilization, in the chemical and construction industries for conveying of toxic substances and chemical solutions. It is not suitable for pumping high-reactive, combustible, caustic liquids, solvents or gasoline.



### KS 80 CW

Type of water pump	<b>for chemical liquids (sea water, chemicals)</b>
Diameter of inlet pipe	<b>80 mm</b>
Maximal productivity	<b>1000 l/min</b>
Nominal speed	<b>3600 rpm</b>
Maximal height of lifting	<b>26 m</b>
Maximal depth of suction	<b>7 m</b>
Engine start	<b>manual</b>
Net dimensions (LxWxH)	<b>590x420x450 mm</b>
Net weight	<b>28 kg</b>



## HIGH-PRESSURE MOTOR PUMP

The pressure head of KS 50HP **high-pressure motor pump** from Könnert & Söhne® can reach 50 m; therefore, this pump is also called the fire pump. It is mainly used to extinguish fire or for other works related to raising water to great height, as well as for pumping clean water, draining tanks and irrigation. The KS 50 HP fire pump can supply water in three directions and has 1 inlet and 3 outlets for connecting hoses: 1x intake hose (50 mm), 1x pressure hose (50 mm) and 2x spare pressure hoses (40 mm). With so many nozzles, water supply speed and overall performance are improved. Water can be pumped in three different directions at the same time with just one unit.



### KS 50 HP

Type of water pump	<b>high-pressure</b>
Diameter of inlet pipe	<b>50 mm</b>
Maximal productivity	<b>500 l/min</b>
Nominal speed	<b>3600 rpm</b>
Maximal height of lifting	<b>50 m</b>
Maximal depth of suction	<b>7 m</b>
Engine start	<b>manual</b>
Net dimensions (LxWxH)	<b>485x434x432 mm</b>
Net weight	<b>29 kg</b>





**KS 50**



**KS 80**



**KS 50HP**

Type of water pump	for clean water	for clean water	high-pressure
Diameter of inlet/outlet pipe, mm	50/50	80/80	50/40, 50, 40
Max. productivity, l/min	500	1000	500
Nominal flowrate, prm	3600	3600	3600
Max. lifting height, m	28	28	50
Max. suction depth, m	7	7	7
Engine type	gasoline 4-stroke	gasoline 4-stroke	gasoline 4-stroke
Engine model	KS 250	KS 250	KS 250
Engine power, hp	7	7	7,0
Engine volume, cm <sup>3</sup>	212	212	212
Engine start	manual	manual	manual
Fuel tank volume, l	3,6	3,6	3,6
Noise level Lpa (7m)/Lwa, dB	79/104	79/104	79/104
Net dimensions (WxLxH), mm	490x400x410	490x400x410	485x434x432
Gross dimensions (WxLxH), mm	510x440x440	510x440x440	495x445x445
Net weight, kg	24	26	29
Gross weight, kg	26	28	31
QR code			



**KS 80MW**



**KS 80TW**



**KS 80CW**

Type of water pump	for mud water	for trash water	for chemical liquids (sea water, chemicals)
Diameter of inlet/outlet pipe, mm	80/80	80/80	80/80
Max. productivity, l/min	1000	1000	1000
Nominal flowrate, prm	3600	3600	3600
Max. lifting height, m	20	26	26
Max. suction depth, m	7	7	7
Engine type	gasoline 4-stroke	gasoline 4-stroke	gasoline 4-stroke
Engine model	KS 280	KS 250	KS 250
Engine power, hp	9,0	7,0	7,0
Engine volume, cm <sup>3</sup>	269	212	212
Engine start	manual	manual	manual
Fuel tank volume, l	6,0	3,6	3,6
Noise level Lpa (7m)/Lwa, dB	79/104	79/104	79/104
Net dimensions (WxLxH), mm	720x535x600	530x460x435	590x420x450
Gross dimensions (WxLxH), mm	725x540x600	540x470x450	605x435x480
Net weight, kg	60	35	28
Gross weight, kg	63	37	30
QR code			



Könnner & Söhnen® engines are reliable, high-performance and cost-effective, and conform to European quality standards, including the latest **standard of emission EURO 5**

## AUTOMATIC BATTERY CHARGER WITH AN SAE PLUG FOR LIFEPO4, AGM LEAD-ACID AND GEL BATTERIES

The easy-to-use compact charger is designed for charging LiFePo4, AGM, Lead-acid and gel batteries with a voltage of 6 V and 12 V, as well as LiFePo4 batteries with a nominal voltage of 12.8 V (4 cells). Such batteries are used in cars, light trucks, tractors, generators, vans, mobile homes, motor boats, etc., with a capacity of up to 45 Ah.

KS-B2A 	
Voltage	6 V/12 V/12.8 V
Operation mode	6 V/12 V/STD/GEL/AGM/LiFePO4
Rated output current	2 A
Nominal input voltage	230 V / 50 Hz
Operation temperature	-10°C +40°C
Accumulator	up to 45 Ah
Cable length	1.8 m
Akumulator	85 Ah
Net dimensions (LxWxH)	92.5×65×35 mm
Net weight	0.3 kg



This automatic charger is designed for use from a power supply with a nominal voltage of 230 V. It has an SAE connector on the charge wire, which allows you to change the type of crocodile clips or ring (supplied in a set), and with the help of a special nozzle that comes with the device, you can change the polarity of the wires.

### The Automatic Battery Charger is protected from

-  Overheating
-  Short circuit
-  Reverse polarity
-  Overcharge





## K&S ACCESSORIES

In the new season, we are introducing to product assortment a full range of accessories. All items are useful and sometimes even indispensable for our products. We also added a range of branded clothing. All presented items can be used both for sales and for promotional activities, customer motivation, and increased loyalty.

### FUEL CANS



	KS CAN 5	KS CAN 10
<b>Special anti-static plastic</b>		
Capacity	5 l	10 l
Dimensions	260x128x255 mm	330x165x300 mm



### MOTOR OIL

The **motor oil** and transmission oil of the Könnér & Söhnen® brand ensures reliable protection of your motor even during continuous operation and under extreme loads, thereby considerably increasing its service life. The use of this oil in our devices ensures smooth, continuous operation.

**Contains top-quality additives from the world-famous Infineum Corporation (Great Britain)**

## ULTRA PERFORMANCE

### Könnér & Söhnen® 10W-30



Volume	1 l
Product quality class	API SL/CF
Class of viscosity	SAE 10W-30



### TRANSMISSION OIL

It reduces friction in moving parts for maximum performance and efficiency, minimizes wear and tear for longer transmission life. An optimally selected composition of additives guarantees smooth operation of the mechanism and effective transmission of power, as well as ensures reliable protection against carbon, sludge and rust deposits. This oil eliminates noise and vibration during operation.

## ULTRA PERFORMANCE

### KS GEAR OIL 80W-90



Volume	1 l
Product quality class	API GL-5
Class of viscosity	SAE 80W-90



**GASOLINE STABILIZER**



<b>KS G-STAB 60</b>	
Könner & Söhnen® ULTRA Performance gasoline fuel stabilizer	
Capacity	250 ml
Dosage	250 ml of additive per 40-60 liters of gasoline fuel

- ✔ Maintains the original quality of gasoline during storage
- ✔ Protects the electric gasoline pump from corrosion and wear, even if moisture enters the system
- ✔ Reliably preserves the fuel system during idle hours
- ✔ As well as enables easy engine start after storage

**Protective glasses** 

**KS GL-1**

Polycarbonate glasses **1 pc**



**Gloves** 

**KS GLOVES L**

100% leather + textile

Reliable protection against mechanical damage



**Cap**

**CAP KS**

Color **gray**



**T-Shirt KS**

Men's (M, L, XL)      Women's (S)



**Polo KS**

Men's (M, L, XL)



**Raglan KS**

Men's (M, L, XL)



## Germany

DIMAX International GmbH  
 info@dimaxgroup.de  
 koenner-soehnen.com/de

## Poland

DIMAX International  
 Poland Sp. z o.o.  
 info.pl@dimaxgroup.de  
 koenner-soehnen.com/pl

## Ukraine

TOB "Техно Трейд КС"  
 sales@ks-power.com.ua  
 koenner-soehnen.com/ua

## France

info.fr@dimaxgroup.de  
 koenner-soehnen.com/fr

## Spain

info.es@dimaxgroup.de  
 koenner-soehnen.com/es

## Romania

info.ro@dimaxgroup.de  
 koenner-soehnen.com/ro

## USA

admin.us@dimaxgroup.de  
 koenner-soehnen.com/en-us

## Great Britain

support.uk@dimaxgroup.de  
 koenner-soehnen.com/en-gb

COMPANY OFFICES 

OFFICIAL REPRESENTATIONS 

AVAILABLE PRODUCTS 

