

**Please, read this manual
carefully before use!**

Owner's Manual



Microinverter

KS MI800W

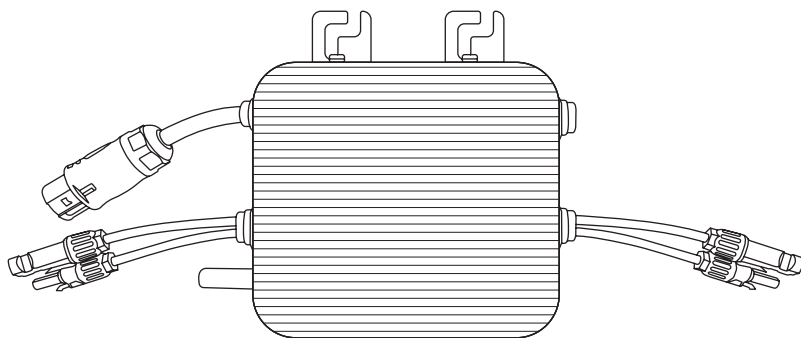



Thank you for opting for **Könnner & Söhnen®** products. This manual contains a brief description of safety, setup and use. More information can be found on the official importer's website in the support section: konner-sohnen.com/manuals

You can also go to the support section and download the manual by scanning the QR code or on the website of the official importer of **Könnner & Söhnen®** at www.konner-sohnen.com



*Please, read this manual
carefully before use!*

The manufacturer of **Könnner & Söhnen®** products reserves the right to make changes that may not be reflected in this manual, namely:

- The manufacturer reserves the right to make changes in the product design, configuration and construction.
- The images and drawings in this manual are for reference only and may differ from the actual components and inscriptions on the products.

Contact information that you are free to use in case of any problems can be found at the end of this manual. All information in this manual is correct to the best of our knowledge and belief at the date of its publication. The current list of service centers can be found on the official importer's website at www.konner-sohnen.com



ATTENTION – DANGER!



Failure to follow the recommendations marked with this sign may lead to serious injury or death of the operator or third parties.



IMPORTANT!



Useful information while operating the machine.

GENERAL DESCRIPTION OF THE MICROINVERTER

1

The microinverter is used in balcony power systems, which consist of:

1. Microinverter
2. Solar panels (not included)
3. Battery station (optional, not included)

*The KS MI800W microinverter and battery station have an integrated WiFi module for connection to a router.

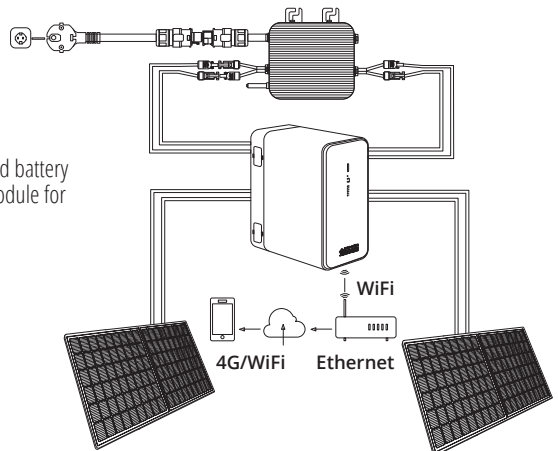



WARNING!



If there is a poor connection in the area where the microinverter is located, it is necessary to install an additional WiFi signal amplifier (repeater) between the router and the microinverter at the appropriate location.

INSTALLATION AND USE OF THE MICROINVERTER

2

1. This manual contains important instructions that need to be followed during the installation and technical maintenance of the microinverter connected to solar panels or batteries. The special symbols indicating dangerous conditions and important safety instructions are used in this document to reduce the risk of electric shock and ensure the safe installation and operation of the microinverter.
2. Technical specifications are subject to change without prior notice - make sure you are using the latest version of the manual available on website of the manufacturer.



ATTENTION - DANGER!



This symbol indicates a situation where non-compliance with instructions could result in serious equipment damage or danger to personnel if improperly applied. Be extremely cautious when performing tasks marked with this symbol.



WARNING!



This symbol indicates important information to ensure optimal operation of the microinverter. Strictly follow these guidelines.

SAFETY GUIDELINES

1. It is FORBIDDEN to disconnect the photovoltaic module from the microinverter without first disconnecting the alternating current power source.
2. Installation or replacement of the microinverter should only be carried out by qualified professionals.
3. All electrical installation work must be carried out in accordance with local electrical standards.
4. Before installing or using the microinverter, be familiar with all instructions and warnings in the technical documentation, as well as with warning labels on the microinverter system and solar panel.
5. Note that the microinverter casing may heat up to 80°C. Therefore, avoid touching it to prevent burns.
6. If the microinverter is not working or has malfunctioned, DO NOT attempt to repair it yourself. Contact technical support. Do not attempt to open the microinverter casing yourself, as this will nullify the warranty.
7. Using non-original accessories not recommended by the manufacturer may cause fire, electric shock, or injury.
8. Do not use the device if it is damaged or improperly modified. A damaged or improperly modified device may operate unpredictably, leading to fire, explosion, or injury.
9. Do not use the device if its cord, plug, or output cable are damaged.
10. Do not disassemble this device yourself. Contact a service center qualified specialist for repair or servicing of this device. Improper assembly may result in fire or electric shock.
11. The device should be serviced by a qualified professional using only original spare parts. This will ensure a safe use of the product.
12. Do not use harmful chemicals or detergents to clean the device.
13. Improper usage, dropping, or applying too much force can lead to damage to the device.
14. Do not stand on the device.
15. Do not use or store this device in areas where flammable substances, explosive gases, or smoke are present.
16. Never leave children unattended with this device.
17. Do not cover the device with towels, clothing, or other items.

INSTALLATION

- The external grounding is connected to the protective grounding contact of the inverter through the alternating current cable. The socket for connecting the microinverter must have grounding contacts.
- During the installation of the microinverter, first connect the alternating current cable to ensure the grounding of the inverter, and then perform the connection of the direct current.
- To disconnect the microinverter, first unplug the alternating current cable plug from the socket, and then disconnect the direct current inputs.
- Never connect the direct current input if the plug of the alternating current cable is disconnected from the mains, under any circumstances.







REGULATION ON RADIO INTERFERENCE

The equipment complies with the CE EMC electromagnetic compatibility standards, which are designed to provide protection against harmful radiation in residential premises. This equipment generates, uses, and emits radio frequency energy. If it's installed or used improperly, it may interfere with radio communication. However, we do not guarantee that interference will not occur in a specific location. If this equipment interferes with the reception of TV or radio signals, try to eliminate the interference. To achieve this, carry out one or more of the following actions:

- change the position of the receiving antenna or move it further away from the equipment;
- ask for assistance from an intermediary or experienced TV or radio technician;
- if the user makes any changes without clear approval from the manufacturer, they may lose the right to use the equipment.

MEANING

3

Symbols	Meaning
	Caution! Risk of electric shock.
	Indicates the risk of personal injury, life hazard, or damage to the micro-inverter if not adhered to.
	Caution! Hot surface.
	This symbol is used for marking electrical and electronic equipment in accordance with Directive 2002/96/EC. It also indicates that the device, accessories, and packaging should not be utilized with unsorted household waste, but should be sorted and utilized separately after the end of their service life. Utilize according to local regulations or contact an authorized representative of the manufacturer for additional information regarding the utilization of used equipment.
	The CE marking on the microinverter confirms that the device complies with the requirements of European directives regarding low-voltage equipment and electromagnetic compatibility.
	Refer to the user manual.

Symbols	Meaning
Qualified personnel	A person who has received appropriate consultation or whose actions are supervised by a qualified electrician, enabling them to understand the risks and avoid dangers associated with electrical current. In the context of safety information contained in this manual, a «qualified professional» is someone familiar with safety requirements, electrical systems, and electromagnetic compatibility, and is competent in matters of electrical connection, grounding, and equipment, system, and cable marking according to established safety procedures. The commissioning and use of the inverter and auxiliary system should only be carried out by qualified personnel.

A GENERAL DESCRIPTION OF THE MICROINVERTER 4



The microinverter is connected to a single-phase grid.

Model number	Alternating current grid
KS MI800W	50/60 Hz, 230 V

COMPONENTS AND SPARE PARTS 5

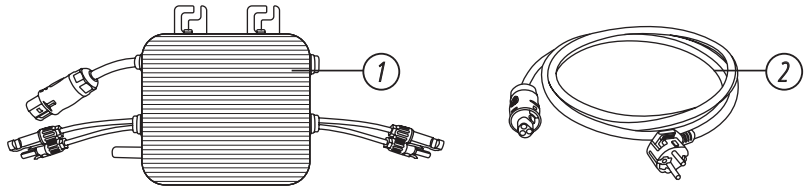

1. Microinverter (1 item)
2. Power cord 5m (1 item)
3. User manual (1 item)



IMPORTANT!   Manufacturer reserves the right to make changes and/or improvements in design, components set and technical attributes without notice and without incurring obligation. The pictures in this manual are schematical and may not match the parameters of original product.

SPECIFICATIONS 6

ATTENTION - DANGER!   Make sure that the voltage and current parameters of your solar panels comply with the following specifications. Refer to the technical passport or user manual.

WARNING!   The maximum idle voltage of the solar panels should not exceed the maximum idle voltage for the microinverter input.

Model	KS MI800W
Input Data (DC)	
Recommended Input Power (STC)	210 – 500 W
Maximum DC Input Voltage	60 V
MPPT Voltage Range	25 – 55 V
Operating Range of DC Voltage	20 – 60 V
Max. Short Circuit Current (DC)	19,5 A×2
Max. Input Current	13 A×2
Output Data (AC)	
Nominal Output Power	800 W
Nominal Output Current	3,6A
Nominal Voltage	230 V
Nominal Frequency	50 Hz
Power Factor	1
Max. Permissible Operating Altitude	< 4000 m
Max. Reverse Current from Inverter to the Panels	0 A
Max Output Short-Circuit Current.	10 A
Max. Output Current	4A
Efficiency	
CEC weighted efficiency	95%
Max Inverter Efficiency	96,5%
Static MPPT Efficiency	99%
Nighttime power consumption	1,2 W
Mechanical characteristics	
Operating Temperature Range	-40 °C +65 °C
Dimensions (LxWxH)	212×230×45 mm
Weight	4 kg
Cooling	Natural convection (no fans)
Enclosure Protection Degree	IP67
Protection Class	Class I
Features	
Compatibility	Compatible with photovoltaic modules on 60 or 72 cells.
Connection type	WiFi
Compliance with Standards	EN50549, VDE0126, VDE4105, IEC62109, CE, CEI021

Name	Status	Explanation
Start indicator	One short red flash one minute after applying DC power to the microinverter indicates successful start. Two or more short red flashes one minute after applying DC power to the microinverter indicate a failure in the setup process.	
Operation indicator	Slowly flashes blue	Generating insufficient power
	Flashes blue quickly	Generating high power
	Flashes red	Generating no power
	Flashes red twice	Low or high alternating current voltage
	Flashes red three times	Grid failure
Ground Fault Detection Interrupt (GFDI) Error	Four red flashes indicate that the microinverter has detected a Ground Fault Detection Interrupt (GFDI) error in the photovoltaic system. The LED will continue to flash four times until the GFDI error is resolved.	

INSTALLATION INSTRUCTIONS AND RECOMMENDATIONS

8

- The photovoltaic system using a microinverter is very simple to install. Each microinverter is easily installed on the rack of the photovoltaic module, directly under the photovoltaic module(s). The photovoltaic module is directly connected to the microinverter using DC cables with MC4 connectors. The installation process **MUST** be carried out in accordance with local electrical standards.
- Pay special attention! An Arc Fault Circuit Interrupter (AFCI) device should not be used to protect the power line to the microinverter socket. Small AFCIs (5–30 mA) do not have protection against reverse currents and may malfunction in case of reverse power flow.
- CAUTION! All electrical installation work must be carried out in accordance with local electrical standards.
- CAUTION! Please note that only qualified professionals should perform the installation or replacement of microinverters.
- CAUTION! Before installing or using the microinverter, be familiar with all instructions and warnings in the technical documentation, as well as with warning labels on the microinverter system and solar panels.
- CAUTION! Remember that there is a risk of electric shock during the installation of this equipment.
- CAUTION! Do not touch the electrically conductive parts of the system, including the photovoltaic panel, while the system is connected to the electrical grid.
- ATTENTION! We strongly recommend installing impulse overvoltage protection devices in the distribution panel.

EQUIPMENT AND TOOLS NEEDED FOR INSTALLATION

9

1. Solar panel mounts
2. Socket wrenches and keys for mounting elements
3. Grounding conductor and grounding washers
4. Phillips screwdriver
5. Torque wrench

INSTALLATION PROCEDURE

10

Mounting the microinverter to the frame or solar panel mounting, or to the wall

- a. Mark the location for the future placement of the microinverter.
- b. Install the microinverter in the appropriate position using mounting elements, anchors, etc.

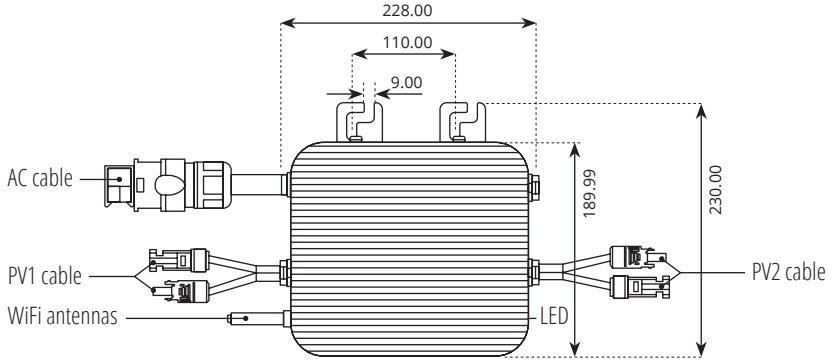

TROUBLESHOOTING

11

Qualified personnel may take the following steps to troubleshoot if the photovoltaic system is not functioning correctly:



ATTENTION – DANGER!



Never disconnect direct current wires while the microinverter is generating power. Before disconnecting, make sure there is no voltage in the direct current wires. You can use non-transparent covering before disconnecting the module.

Error	Possible cause
Possibly, the issue is within the microinverter itself.	A possible malfunction can be indicated by the red LED of the microinverter: it should blink or light up; if it does not blink or light up at all, the problem is definitely in the microinverter itself.
The microinverter itself is functioning normally, but there is an issue with the connection between the microinverter and the network. The mentioned problems are related to the microinverter, not the connection.	<p>The data is not displayed on the screen: data is not displayed on the website or in the application. Check the network settings.</p> <p>Only the microinverter is displayed on the network, but there is no data. This may be related to a server update.</p>

TROUBLESHOOTING PROCEDURE

- A:** Make sure that the power grid voltage and frequency are within the ranges specified in the “Technical Specifications” section of this manual.
- B:** Check the connection to the power grid. First, turn off the alternating current power, then the direct current, and ensure that voltage in the power grid can be measured at the alternating current connector. Never disconnect the direct current wires while the microinverter is operating. Reconnect the direct current module connectors and wait for three short LED flashes.
- C:** Make sure that all alternating current switches are functional and closed.
- D:** Check the direct current connections of the microinverter and photovoltaic module.
- E:** Make sure that the direct current voltage of the photovoltaic module is within the permissible range specified in the technical specifications of this manual.
- F:** If the issue stays the same, contact technical support.

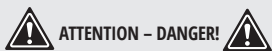

If the microinverter is not working or has malfunctioned, DO NOT attempt to repair it yourself. If troubleshooting methods do not help, contact technical support.

PROCEDURE FOR REPLACING MALFUNCTIONING MICROINVERTERS

- A: Disconnect the plug of the microinverter alternating current cable from the socket.
- B: Cover the solar panels with a non-transparent covering.
- C: Disconnect the direct current wires from the microinverter.
- D: Remove the microinverter from its mounting.
- E: Install the new microinverter, then remove the non-transparent covering from the solar panels.
- F: Connect the alternating current cable from the new microinverter.

CONNECTION DIAGRAM 12

Possible connection options without and with the KS 2240BSB battery system.

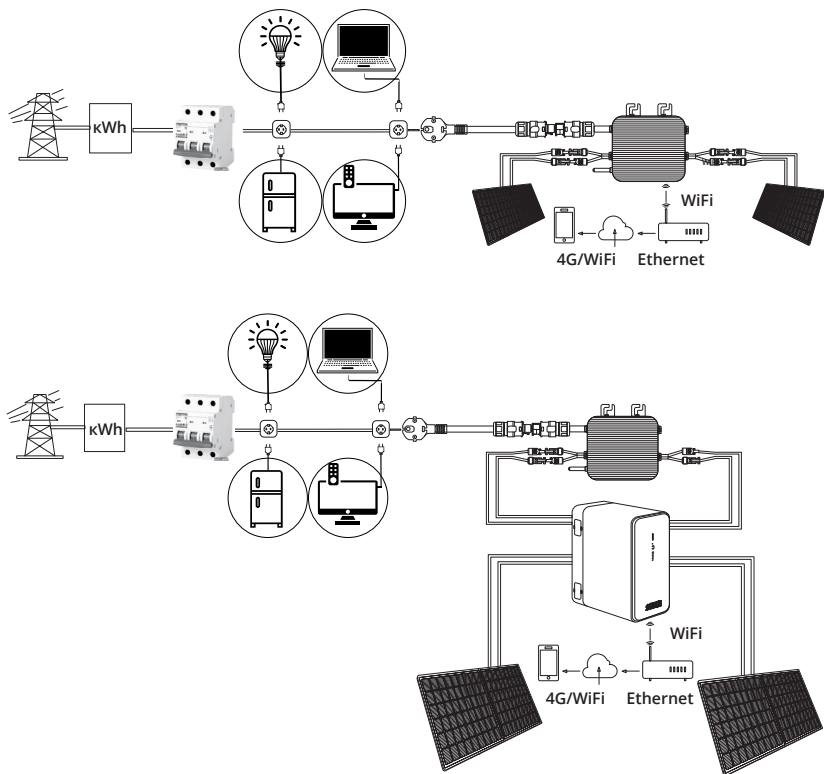

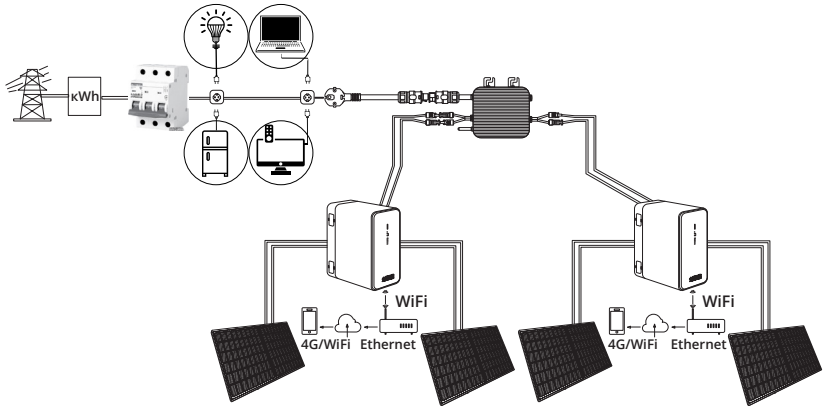

THE MICROINVERTER CONNECTING TO THE WIFI NETWORK

13

STEP 1.

Download the (Smart Life) application from the App Store, scan the QR code below, or download the application from this link:



<https://developer.tuya.com/cn/docs/iot/user-manual-for-tuya-smart-v3177?id=K9obrofrfk4sk>

STEP 2. Activate Bluetooth and WiFi.

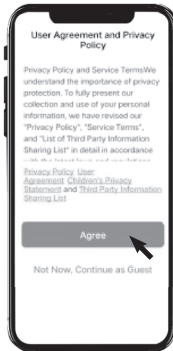

STEP 3

Launch the application.

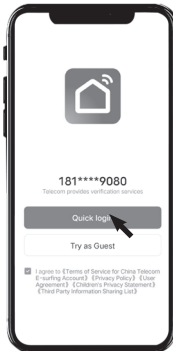

STEP 4.

Complete a quick system login.

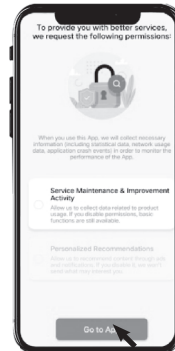

STEP 5

Open the application.

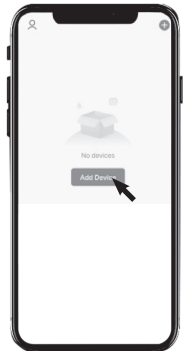

STEP 6

Add a new device.

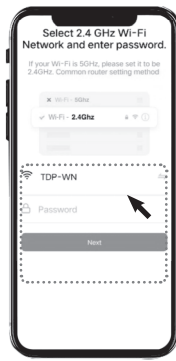

STEP 7
Select the WiFi network and enter its password.



STEP 8
The equipment has successfully started sharing the WiFi signal, approximately 30S.

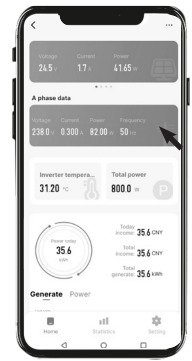

STEP 9
The interface showing all parameters is displayed on the screen, indicating that the process is complete.

Swipe left to right to view the input parameters of the photovoltaic modules.



NOTE



If you need to use a device that you have used before, or connect a new phone, first disconnect your previous phone from the application. Otherwise, other phones will not be able to connect to the WiFi network.

STEP 10. WIFI SETTINGS RESET

Usually, WiFi operates automatically and does not require resetting settings. The reset button is only needed in certain cases, such as when the initial route is interrupted or cannot be unlinked in the mobile application. To reset WiFi settings, press and hold the reset button for approximately 10 seconds. After resetting WiFi settings, you can set them up again.

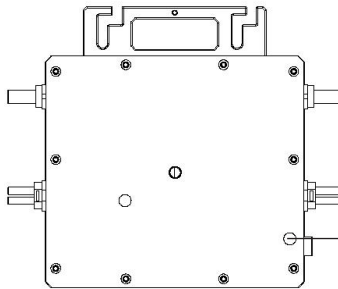

The reset button is hidden and covered by a waterproof film. The reset button can only be seen by opening the film. After resetting the settings, be sure to close the film to prevent water from entering the device.



EC Declaration of Conformity

Nr. 186

The following products have been tested by us with the listed standards and found in compliance with the European Community Electromagnetic compatibility Directive (EMC) 2014/30/EC, Low Voltage Directive 2014/35/EC.

Manufacturer: DIMAX INTERNATIONAL GmbH
Address: Flinger Broich 203, 40235 Duesseldorf, Germany
Product: Micro Inverter "Können & Söhnen"
Type / Model: KS MI800W

The statement is based on a single evaluation of above mentioned products. It does not imply an assessment of the whole production and does not permit the use of the test lab. logo. The manufacturer should ensure that all product in series production are in conformity with the product sample detailed in this report. The applicant should hold the whole technical report at disposal of the competent all the right.

Applied EC Directives: 2014/30/EC Electromagnetic compatibility Directive (EMC)
2014/35/EU Low Voltage

Applied Standards: EN IEC 61000-6-3: 2021
EN IEC 61000-6-4: 2019
EN IEC 61000-6-1: 2019
EN IEC 61000-6-2: 2019
EN 62109-1:2010
EN 62109-2:2011



Issued Date:
Place of issue:
Director:

2024-03-21
Duesseldorf
Fomin P.

P. Fomin

DIMAX
International GmbH
Flinger Broich 203 40235 Düsseldorf
USt-ID DE296177274
koenner-soehnen.com

We DIMAX INTERNATIONAL GmbH hereby declare that specified above conforms covering European Parliament and Council Directives, Electromagnetic compatibility Directive (EMC) 2014/30/EC of 26 February 2014, 2014/35/EC Low Voltage Directive of 26 February 2014. The CE mark above can be used under the responsibility of manufacturer. After completion of an EC declaration of Conformity and compliance with all relevant EC directives.

CONTACTS

Deutschland:

DIMAX International GmbH
Flinger Broich 203 -FortunaPark-
40235 Düsseldorf, Deutschland
www.koenner-soehnen.com

Ihre Bestellungen

orders@dimaxgroup.de

Kundendienst, technische Fragen und Unterstützung

support@dimaxgroup.de

Garantie, Reparatur und Service

service@dimaxgroup.de

Sonstiges

info@dimaxgroup.de

Polska:

DIMAX International
Poland Sp.z o.o.

Polska, Warszawska,
306B 05-082 Stare Babice,
info.pl@dimaxgroup.de

Україна:

ТОВ «Техно Трейд КС»,
вул. Електротехнічна 47, 02222,
м. Київ, Україна

sales@ks-power.com.ua
